

WILDFIRE
SPREADING INNOVATION



GAS & ELECTRIC APPLIANCES 2024/25

Exquisite fires for elegant homes

Contents

All about Wildfire 4-5

Gas Fires

Some things you need to know 6-7

Function and Performance 8-9

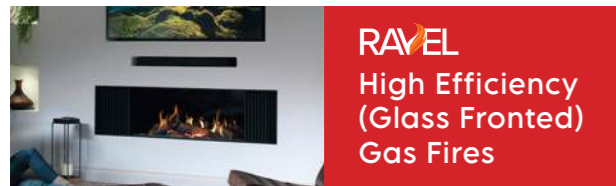

Ravel 1500 Media Suite (Balanced Flue) 10-11
for homes with no flue

Ravel 1720 Media Suite (Balanced Flue) 12-13
for homes with no flue

Ravel 750 (Asti 750 Suite) Limestone 14-15
for standard flues

Ravel 750 (Valentia Suite) Micro Marble 16-17
for standard flues

Ravel 800 (Asti 800 Suite) Limestone 18-19
for standard flues

Ravel 800 (Siena Suite) Micro Marble 20-21
for standard flues

Ravel 800 (HIW) 22-23
for standard flues

Ravel 800BF (Asti BF 800 Suite) Limestone 24-25
for standard flues

Ravel 600 (Asti 600 Suite) Limestone 26-27
for standard flues

Ravel 600 (Amalfi Suite) Micro Marble 28-29
for standard flues

Ravel 600 (HIW) 30-31
for standard flues

Ravel 600BF (Asti BF 800 Suite) Limestone 32-33
for standard flues

Ravel 550 (Emelia Suite) Micro Marble 34-35
for standard flues

Ravel 550 HE Inset Stove (Emelia Suite) 36-37
for standard flues

Ravel 400 HE (Salvador Suite) 38-39
for standard flues

Ravel 400 Inset Stove (Salvador Suite) 40-41
for standard flues

Ravel 400 HE (HIW) 42-43
for standard flues

Ravel 400 HE (Balanced Flue) 44-45
for homes with no flue

Ravel 400C Gas Stove 46-47
for standard flues

Ravel 400T Gas Stove (Asti 750 Chamber Suite) 48-49
for standard flues

Ravel 400 BF Gas Stoves 50-51
for homes with no flue



BF96OSL (Balanced Flue) 52-53
for homes with no flue

Thermes (Balanced Flue) 54-55
for homes with no flue

Ellipsis (HIW / Hearth Mount) 56-57
A range of options featuring the Ellipsis trim

HE950L (Asti Suite) 58-59
for standard and precast flues

HE950L (Seville Suite) 60-61
for standard and precast flues

HE900 (Avellino Suite) 62-63
for standard and precast flues

Cressida HE 64-65
for standard flues

Pesaro HE Slimline 66-67
for standard and precast flues



Cavello XE 68-69
Full Depth Convector Open Fronted for standard flues

Montese (Cadiz Suite) 70-71
Radiant full Depth Open Fronted for standard and precast flues

Ceralis (Salerno suite) 72-73
Radiant Open Fronted for standard & precast flues



Trim Options 74
Choose a trim for your Gas Fire

Technical information for all gas appliances 75

Electric Fires

Some things you need to know 76-77



HE 900E (Avellino Suite) 78-79
for Flat Wall installation

HE 950LE (Seville Suite) 80-81
for Flat Wall installation

Panama E22 (Salvador Suite) 82-83
Widescreen Electric Fireplace

Ravel E16 (Salvador Suite) 84-85
16x22 Electric Fireplace



Trim Options 86
Choose a trim for your Electric Fire

Fireplace dimensions for all Electric Fireplace Suites 87

Exquisite fires for elegant homes

Wildfire are dedicated to the design and manufacture of innovative and attractive fireplaces for British homes. At Wildfire we are committed to providing the highest quality heating products with a proven performance. Our innovative range of gas and electric fireplace suites have been tested to comply with the latest British and European standards and are manufactured in an ISO certified factory.



Wildfire are a multi award winning gas appliance manufacturer.

The HE950L Seville Suite was named not only Gas fireplace suite of the year, but also 'Product of the Year' at the Hearth and Home exhibition.

New for the 2024/2025 are the impressive Ravel 600 Balanced Flue (Asti Suite) and the 950L (Asti Suite). Contact your dealer for a demonstration.

The Wildfire gas product range includes many products which have been designed and approved with efficiency at their core. In a world where energy costs have soared we believe it is important to obtain the absolute maximum from your heating appliance.

With this in mind the net efficiency of Wildfire open fronted gas fires are up to 62% and the glass fronted fires up to 87.2%. So when you purchase a Wildfire heating product you can be confident that you will be installing a product that will deliver in all installation scenarios. Here at Wildfire we are devoted to innovative design whilst maintaining maximum functionality. All Wildfire slide control gas fires feature the latest patented Direct Slide technology.

Wildfire is the premier gas and electric appliance brand from Hearth Products Limited. Hearth Products has been actively involved in design and technology for the fireplace industry across the globe since 2003. Our product technologies have been used in products across Europe, Australia and North America.

See full details of our product range at either www.wildfiregas.co.uk or www.wildfireelectric.co.uk



HE950L Seville Suite



Some things you need to know

Do I need a Convector or a Radiant Gas Fire?

It is important to know the difference between Radiant heat and Convected heat.

Radiant heat. In short, Radiant heat is emitted from all Wildfire appliances. This type of heat is actually infrared and heats objects in the room. Radiant heat is considered to be the most comfortable and natural form of heat.

Convected heat warms the air in the room. By passing the cooler air which enters the appliance at the bottom, through a heat exchanger, it warms up, then emits the hotter air back into the room from the top of the appliance.

Do I need a Glass Fronted Gas Fire?

A glass fronted fire will be more efficient and therefore more cost effective to run. Glass fronted appliances are usually more expensive to buy.

In general terms, it is usually more cost effective to purchase a glass fronted appliance if it is to be used more regularly as the efficiency savings will provide a quicker payback for the more expensive appliance. It is also important to remember that a glass fronted appliance will normally provide a similar amount of heat to an open fronted appliance, however, as it is more efficient, it is cheaper to run.



We guarantee* our gas fire products for a period of 5 years from installation and our customer service staff are always on hand to help you with any query you may have with your product.

Our 5 year limited guarantee* is managed directly by Wildfire through our extensive network of service centres throughout the UK. Choose Wildfire for style, performance, reliability, value and peace of mind.



What type of flue do I have?



Brick Chimney



Pre-Fabricated



Pre-Cast



Balanced Flue

You will need to know what type of flue you have in your home. You will see these icons on each product page which will show if the appliance is suitable for your property. It may be that you have a Brick Chimney (otherwise known as a Class 1 flue), a Pre-Fabricated Metal System (which can be a Class 1 or Class 2 flue) or a Pre-Cast Flue (a flue which is built into the inner brickwork of your home). If you do not have a chimney or flue system in your home then you will need to look for a balanced flue gas fire which, if you already have a balanced flue gas fire in the property, is usually indicated by a flue terminal concealed within a basket on the outside of the property.



What control options are available?



Manual Control



Slide Control



Manual Electronic Control

All Wildfire products are available with a Direct Slide option giving you the ease of reliable and simple operation. The slide control provides ignition, flame control and turns the fire off when you're finished. Most of the Wildfire range is available in manual control too — these fires have a removable cover at the base of the fire where the rotary control and igniter are situated.

Wildfire have now introduced electronic ignition on the majority of the manual control range.

What type of gas do I need?



Natural Gas



Propane

Wildfire appliances are all available in natural gas.

Wildfire products available in LPG:
Ravel 400 (CF)
Ravel Stove 400C (CF)
Ravel Stove 400T (CF)
Ravel 600 (CF)

Function & Performance

O.D.S

The Oxygen Depletion Sensor will automatically shut off the gas supply to the burner if the oxygen level in the room falls below a particular level. This is important as it will turn off the appliance should the flue become blocked or a lack of ventilation occurs.

F.S.D

The Flame Supervision Device is designed to sense the presence of a flame. Should the flame be extinguished for any reason then the safety device will cut off the supply of gas to the burner.

Optional Ezi-Grip Handle



Most Wildfire appliances can be fitted with an elderly/infirm handle to ease the lighting operation. This larger handle is much easier to access and move so if you think that this may be a requirement then talk to your retailer who will demonstrate the Ezi-Grip system. This handle is purchased as an accessory and is fitted at the point of installation of the appliance.

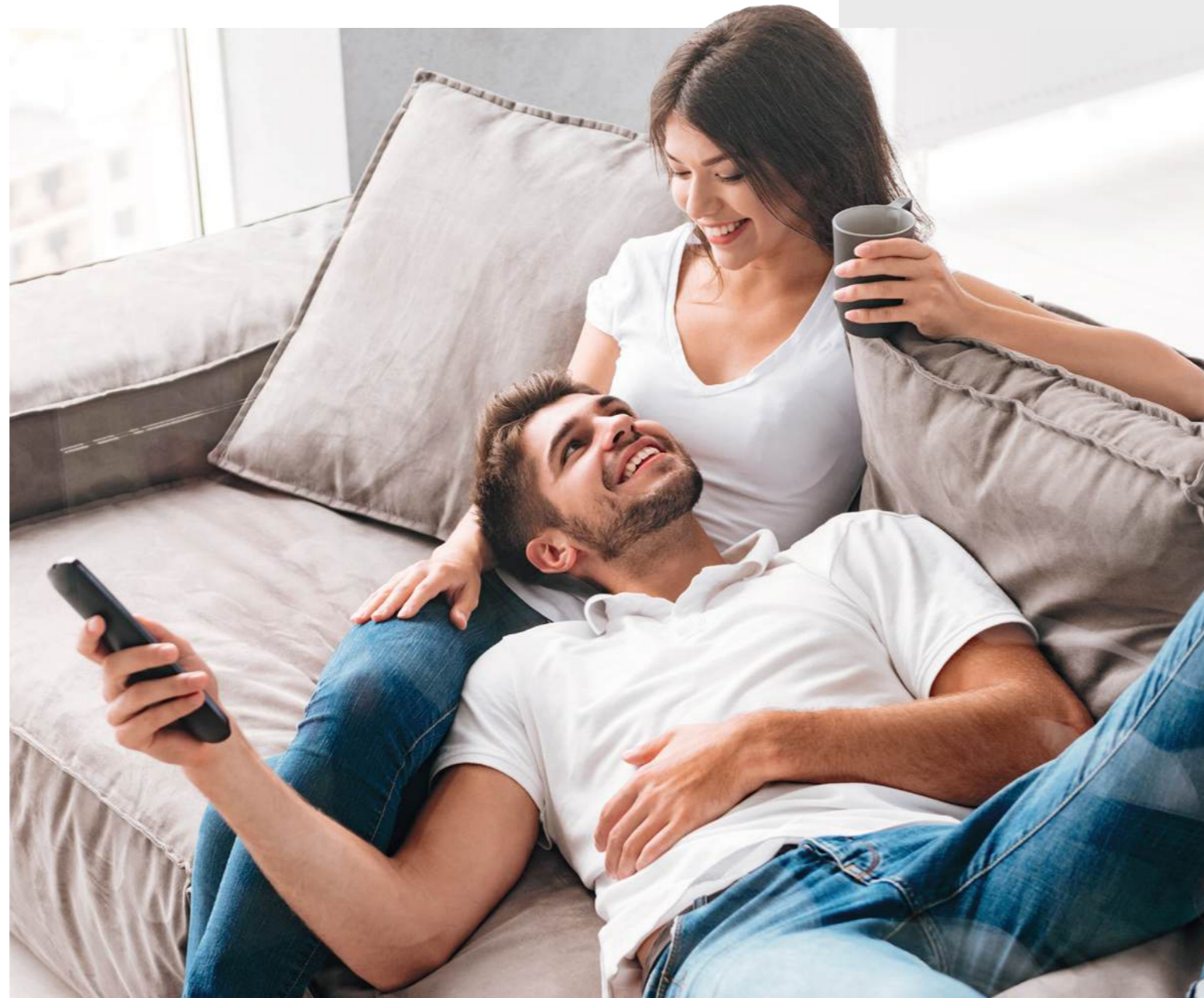

The Wildfire range is proud to now include a range of glass fronted high efficiency gas fires. These products feature the latest technology in high output gas fires and deliver the most effective way of heating your living room. The range includes both mid-depth convector and full depth convector products, both available with Direct Slide Technology. The Ravel 400 appliance can also be installed into a hole in the wall by fitting the 4 sided HIW trim (see pages 42 and 43) and with inset stove trim (see pages 40 and 41). The balanced flue gas fires are a high efficient appliance solution for homes with no chimney, the Thermes & Ravel 400 BF deliver heat, value for money, efficiency and are available with a large range of trim options.



Open fronted appliances are designed to operate with the revolutionary XE system which is only available from Hearth Products. This new efficiency system is designed to 'tune' the appliance to your fireplace flue, thereby ensuring you obtain the maximum output from the appliance.



Regulations demand that gas fires must be installed by a Registered Gas Safe Engineer. For further information regarding Gas Safe requirements contact Wildfire directly, where we will be happy to give you advice. Warranty will be void if the appliance is not fitted in accordance to these legal requirements.



RAVEL 1500 Media Wall

Balanced Flue



HE



FLUE OPTION



Balanced Flue

CONTROL



Slide

FUEL BED



Log

FUEL



Natural Gas

WATCH VIDEO



Scan QR Code

GAS CONSUMPTION

75% EFFICIENCY

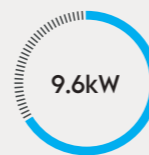

Heat Input (High)

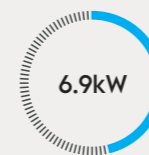

Heat Input (Low)



Heat Output (High)



Heat Output (Low)

ENERGY EFFICIENCY CLASS E

The Ravel 1500 MW fire provides an astonishing solution for a gas media wall.

This balanced flue appliance will provide the heart to your media wall. With impressive heat and an unrivalled flame picture, the fuel bed is intricately detailed to reveal the perfect log fire. A convection system forces cooler air through the side grills and up through side outlets at the top of the chimney breast, or through a stylish linear outlet above the television. The installation allows all the unsightly cables to be concealed whilst delivering a stylish and functional media wall to your home. Spot heating with a gas appliance is the most cost effective method to heat a room, allowing the central heating boiler to be turned off for longer periods...the Ravel Media Wall fire is a powerhouse of heat.

DIMENSIONS

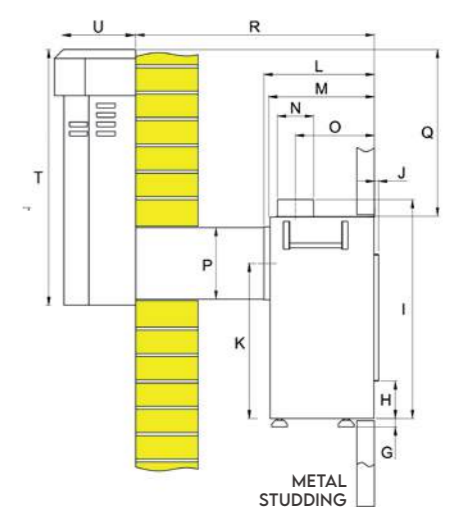
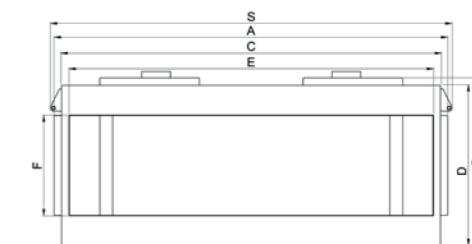

- A) 1591mm
- B) 677mm
- C) 1538mm
- D) 650mm
- E) 1473mm
- F) 407mm
- G) 27-60mm
- H) 120mm
- I) 703mm
- J) 13mm
- K) 498mm
- L) 355mm
- M) 339mm
- N) Ø116mm
- O) 253mm
- P) Ø230mm
- Q) 535mm
- R) 521-766mm
- S) 1623mm
- T) 825mm
- U) 260mm

TRIM DIMENSIONS

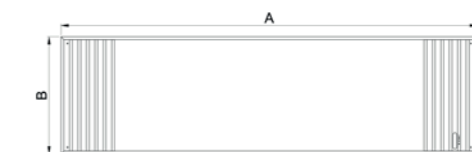

- A) 1481mm
- B) 415mm

RAVEL 1720 Media Wall

Balanced Flue



FLUE OPTION



Balanced Flue

CONTROL



Slide

FUEL BED



Log

FUEL



Natural Gas

WATCH VIDEO



Scan QR Code

GAS CONSUMPTION

75% EFFICIENCY

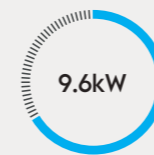

Heat Input (High)

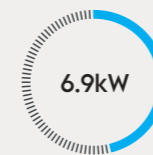

Heat Input (Low)



Heat Output (High)

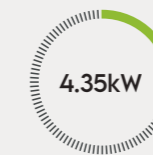

Heat Output (Low)

ENERGY EFFICIENCY CLASS E

DIMENSIONS

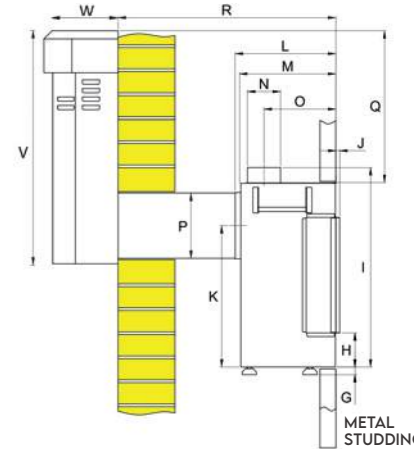
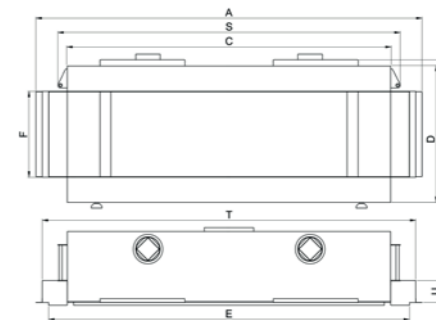

A) 1831mm	G) 27-60mm	M) 339mm	S) 1623mm
B) 667mm	H) 120mm	N) Ø116mm	T) 1711mm
C) 1538mm	I) 703mm	O) 253mm	U) 104mm
D) 650mm	J) 13mm	P) Ø230mm	V) 825mm
E) 1711mm	K) 498mm	Q) 535mm	W) 260mm
F) 407mm	L) 355mm	R) 521-766mm	

TRIM DIMENSIONS

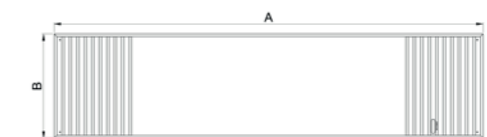

A) 1721mm
B) 415mm

LINEAR VENT DIMENSIONS

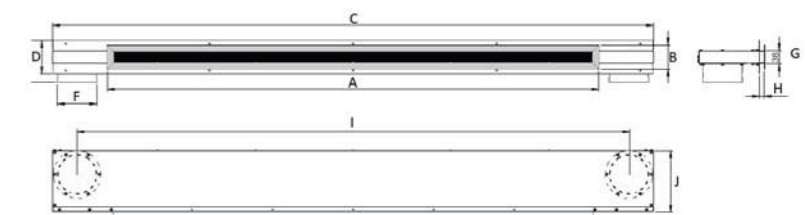

A) 1450mm	D) 98mm	G) 38mm	J) 182mm
B) 70mm	E) 124mm	H) 11.5-16.5mm	
C) 1772mm	F) Ø116mm	I) 1627.5mm	

The Ravel 1720 MW fire provides a wider version of the 1500MW suitable for the larger sized TV.

This balanced flue appliance will provide the heart to your media wall. With a massive heat output and an unrivalled flame picture, the fuel bed is intricately detailed to reveal the perfect log fire. A convection system forces cooler air through the side grills and up through side outlets at the top of the chimney breast, or through a stylish linear outlet above the television. The installation allows all the unsightly cables to be concealed whilst delivering a stylish and functional media wall to your home. Spot heating with a gas appliance is the most cost effective method to heat a room, allowing the central heating boiler to be turned off for longer periods...the Ravel 1720 Media Wall fire is a powerhouse of heat combined with ultra realism.

RAVEL 750

(Asti 750 Suite) Limestone



Ravel 750 Edge trim, installed into the Asti 750 Limestone Suite. Inset: Ravel 750 shown with standard (wide) trim.



CONTROL



Slide

FUEL BED



Log

FUEL



Natural Gas

FLUE OPTIONS



Brick Chimney



Pre-Fabricated

WATCH VIDEO



Scan QR Code

GAS CONSUMPTION

78% EFFICIENCY

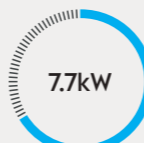

Heat Input (High)



Heat Input (Low)



Heat Output (High)

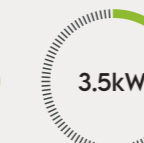

Heat Output (Low)

ENERGY EFFICIENCY CLASS E

Dimensions

EDGE

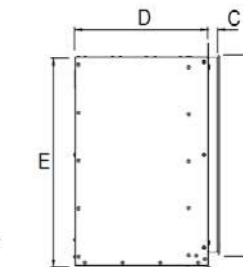
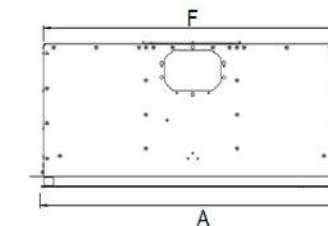

- A) 748mm
- B) 711mm
- C) 18-32mm
- D) 280mm
- E) 736mm
- F) 747mm

STANDARD

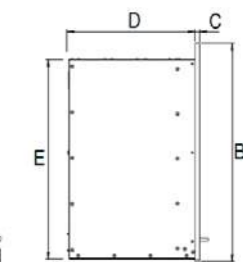
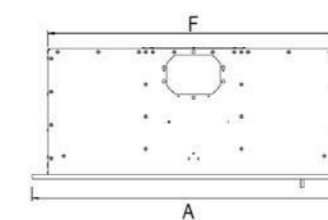

- A) 807mm
- B) 770mm
- C) 10mm
- D) 280mm
- E) 736mm
- F) 747mm

MANTEL DIMENSIONS

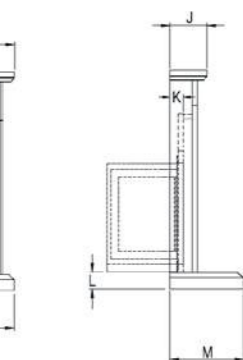
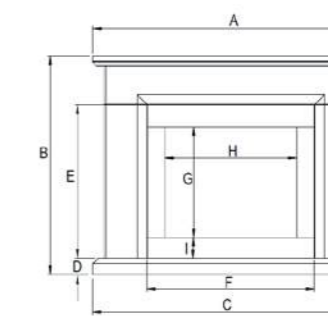

EDGE TRIM

- G) 702mm
- H) 740mm
- I) 70mm

STANDARD TRIM

- G) 741mm
- H) 756mm
- I) 40mm

- A) 1300mm
- B) 1120mm
- C) 1280mm
- D) 60mm

- E) 820mm
- F) 840mm
- J) 160mm
- K) 45mm

- L) 100mm
- M) 380mm

The Ravel 750 joins the family of Ravel products from Wildfire. This glass fronted gas fire is suitable for both class 1 and class 2 flues.

The Ravel 750 features the latest in under-log burner technology is sure to impress with its stunning fuel bed layout. The graceful and ingenious burner system allows the fire to be turned to low whilst still retaining an impressive flame picture.

Shown here in the Asti 750 Limestone surround, installed with the sleek Edge trim, for the trimless look. The Ravel 750 Asti suite is the culmination of years of research, development and manufacturing excellence, producing the ultimate gas log fire.

RAVEL 750

(Valentia Suite) Micro Marble



Ravel 750 Edge trim, installed into the Asti 750 Limestone Suite. Inset: Ravel 750 shown with standard (wide) trim.



CONTROL



Slide

FUEL BED



Log

FUEL



Natural Gas

WATCH VIDEO



Scan QR Code

FLUE OPTIONS



Brick Chimney



Pre-Fabricated

STANDARD MANTEL FINISH OPTIONS

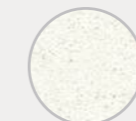

White

GAS CONSUMPTION

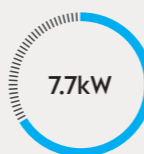

Heat Input (High)



Heat Input (Low)



Heat Output (High)

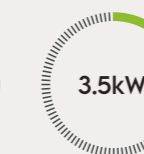

Heat Output (Low)

78% EFFICIENCY

ENERGY EFFICIENCY CLASS E

Dimensions

EDGE

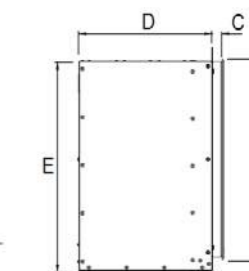
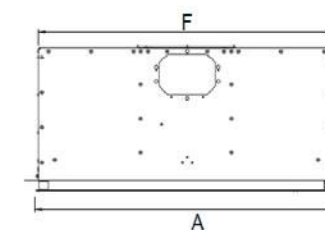

- A) 748mm
- B) 711mm
- C) 18-32mm
- D) 280mm
- E) 736mm
- F) 747mm

STANDARD

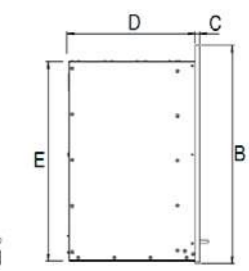
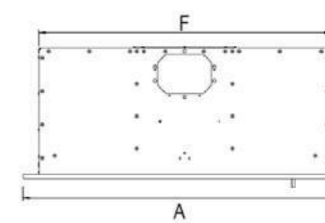

- A) 807mm
- B) 770mm
- C) 10mm
- D) 280mm
- E) 736mm
- F) 747mm

MANTEL DIMENSIONS

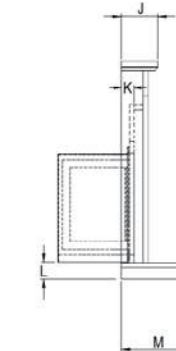
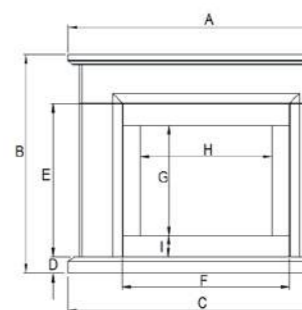

- A) 1370mm
- B) 1150mm
- C) 1370mm
- D) 65mm
- E) 874mm
- F) 928mm
- G) 702mm
- H) 740mm
- I) 65mm
- J) 170mm
- K) 50mm
- L) 100mm
- M) 300mm

Note: The Valentia marble suite is only available to suit the Edge style trim as shown.

The Ravel 750 joins the family of Ravel products from Wildfire. This glass fronted gas fire is suitable for both class 1 and class 2 flues.

The Ravel 750 features the latest in under-log burner technology is sure to impress with its stunning fuel bed layout. The graceful and ingenious burner system allows the fire to be turned to low whilst still retaining an impressive flame picture.

Shown here in the Valentia micro marble surround, installed with the sleek Edge trim, for the trimless look. The Ravel 750 Valentia suite is the culmination of years of research, development and manufacturing excellence, producing the ultimate gas log fire.

RAVEL 800 | (Asti 800 Suite) Limestone



Ravel 800 Edge trim, installed into the Asti Limestone Suite. (Standard trim shown inset).

CONTROL FUEL BED FUEL



FLUE OPTIONS



WATCH VIDEO



Scan QR Code

GAS CONSUMPTION

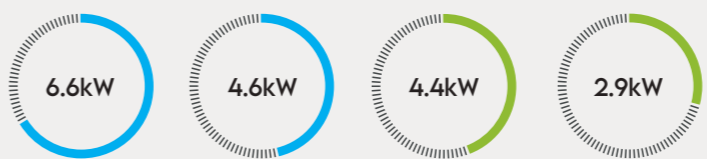

ENERGY EFFICIENCY CLASS E

The Ravel 800 is one of the most exciting developments from Wildfire. This glass fronted gas fire is suitable for both class 1 and class 2 flues.

The Ravel 800 features the latest in under-log burner technology and is sure to impress with its stunning fuel bed layout.

The unique burner system allows the fire to be turned to low whilst still retaining an impressive flame picture.

Shown here in the Asti Limestone surround, this fire is available with two trim styles, the Edge trim, for the sleek trimless look or the conventional style Standard trim.

Dimensions

EDGE

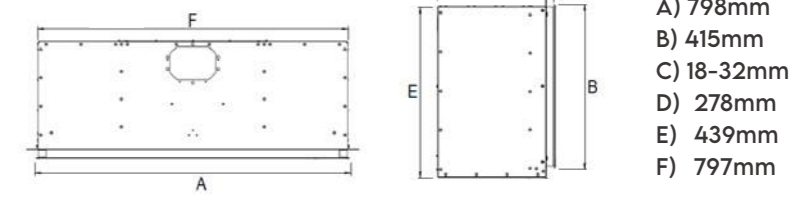

- A) 798mm
- B) 415mm
- C) 18-32mm
- D) 278mm
- E) 439mm
- F) 797mm

STANDARD

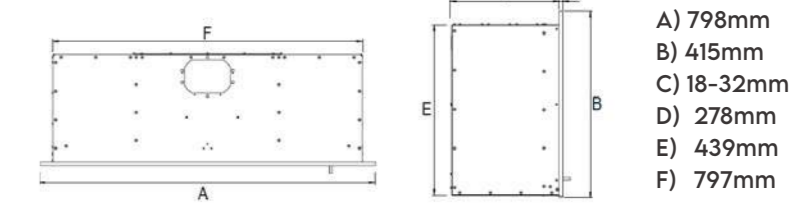

- A) 798mm
- B) 415mm
- C) 18-32mm
- D) 278mm
- E) 439mm
- F) 797mm

MANTEL DIMENSIONS

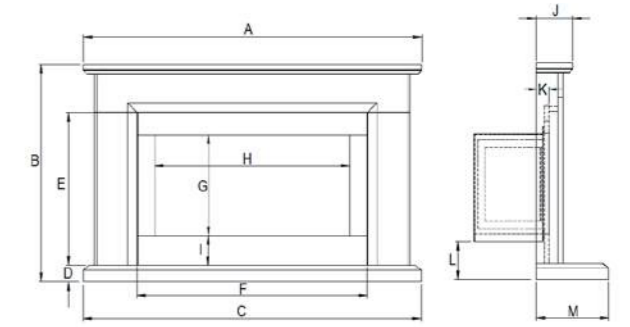

- EDGE TRIM**
- G) 406-408mm
- H) 790-792mm
- I) 124mm
- STANDARD TRIM**
- G) 444-446mm
- H) 806-808mm
- I) 95mm

- A) 1307mm
- B) 864mm
- C) 1307mm
- D) 60mm
- E) 594mm
- F) 927mm
- J) 140mm
- K) 50mm
- L) 155mm
- M) 300mm

RAVEL 800

(Siena Suite) Micro Marble



Ravel 800 Edge trim, installed into the Siena Marble Suite (Standard trim shown inset).

CONTROL



Slide

FUEL BED



Log

FUEL



Natural Gas

WATCH VIDEO



Scan QR Code

FLUE OPTIONS



Brick Chimney



Pre-fabricated

STANDARD MANTEL FINISH OPTIONS

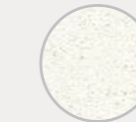

White

GAS CONSUMPTION

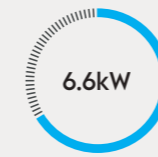

6.6kW
Heat Input (High)

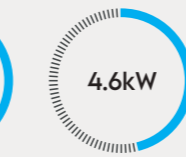

4.6kW
Heat Input (Low)

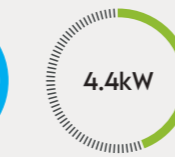

4.4kW
Heat Output (High)

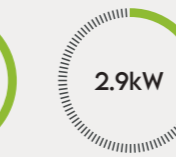

2.9kW
Heat Output (Low)

75% EFFICIENCY

ENERGY EFFICIENCY CLASS E

Dimensions

EDGE

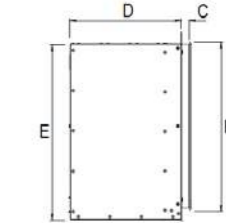
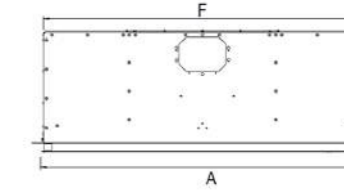

- A) 798mm
- B) 415mm
- C) 18-32mm
- D) 278mm
- E) 439mm
- F) 797mm

STANDARD

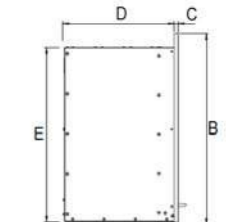
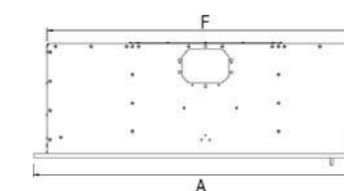

- A) 857mm
- B) 474mm
- C) 10mm
- D) 278mm
- E) 439mm
- F) 797mm

MANTEL DIMENSIONS

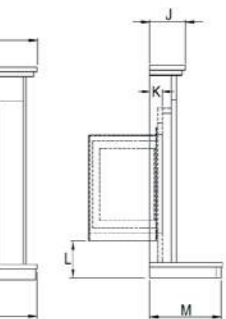
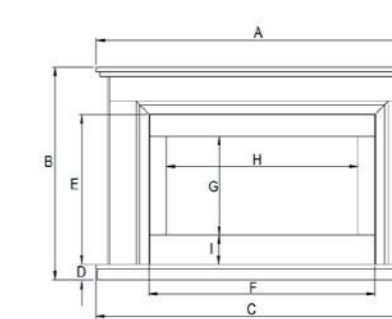

- #### EDGE TRIM
- G) 406-408mm
 - H) 790-792mm
 - I) 119mm

- #### STANDARD TRIM
- G) 444-446mm
 - H) 806-808mm
 - I) 90mm

- A) 1370mm
- B) 875mm
- C) 1370mm
- D) 65mm
- E) 614mm
- F) 928mm
- J) 145mm
- K) 50mm
- L) 155mm
- M) 300mm

The Ravel 800 is one of the most exciting developments from Wildfire. This glass fronted gas fire is suitable for both class 1 and class 2 flues.

Shown here in the Siena Micro marble surround, this fire is available with two trim styles, the Edge trim, for the sleek trimless look or the conventional style Standard trim.

The Ravel 800 features the latest in under-log burner technology and is sure to impress with its stunning fuel bed layout. The unique burner system allows the fire to be turned to low whilst still retaining an impressive flame picture.

RAVEL 800 | HIW



Ravel 800 installed as 'Hole in the wall' with Edge trim, (Standard wider trim shown inset).



CONTROL



FUEL BED



FUEL



FLUE OPTIONS



WATCH VIDEO



Scan QR Code

GAS CONSUMPTION

75% EFFICIENCY



Heat Input (High)



Heat Input (Low)



Heat Output (High)

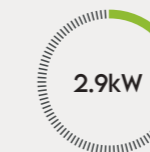

Heat Output (Low)

ENERGY EFFICIENCY CLASS E

Dimensions

EDGE

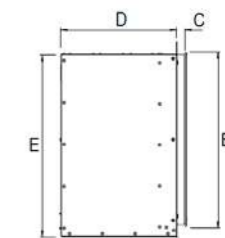
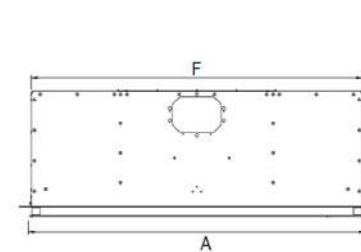

A) 798mm
B) 415mm

C) 18-32mm
D) 278mm

E) 439mm
F) 797mm

STANDARD

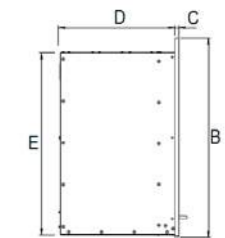
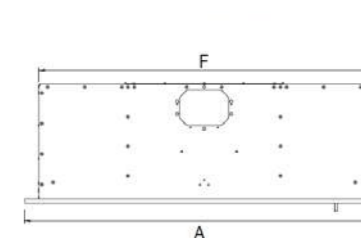

A) 857mm
B) 474mm

C) 10mm
D) 278mm

E) 439mm
F) 797mm

The Ravel 800 is one of the most exciting developments from Wildfire. This glass fronted gas fire is suitable for both class 1 and class 2 flues.

Shown here installed with the Ravel 800 Edge trim directly into a fireplace wall for a minimalistic look.

The Ravel 800 features the latest in under-log burner technology and is sure to impress with its stunning fuel bed layout. The unique burner system allows the fire to be turned to low whilst still retaining an impressive flame picture.

RAVEL 800BF | (Asti BF 800 Suite) Limestone



HE

CONTROL



Slide

FUEL BED



Log

FUEL



Natural Gas

FLUE OPTIONS



Balanced Flue

WATCH VIDEO



Scan QR Code

GAS CONSUMPTION

78% EFFICIENCY



Heat Input (High)



Heat Input (Low)

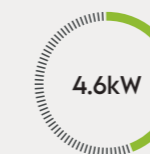

Heat Output (High)

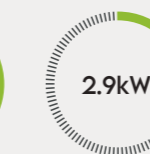

Heat Output (Low)

ENERGY EFFICIENCY CLASS E

The Ravel 800 BF is a new product designed to operate in buildings without chimneys or flues. This product follows in the footsteps of its extremely successful sister model the Ravel 800 (conventional flue).

The Ravel 800BF incorporates all of the features available on other Ravel products including underlog burner technology, turndown function allowing the rear burners to be turned off to retain flame picture on low and a reliable and easy to use slide control system.

Shown here in the Asti 800BF Limestone suite, this fire is only available with the Edge trim, for the sleek trimless look (supplied with product).

Dimensions

EDGE

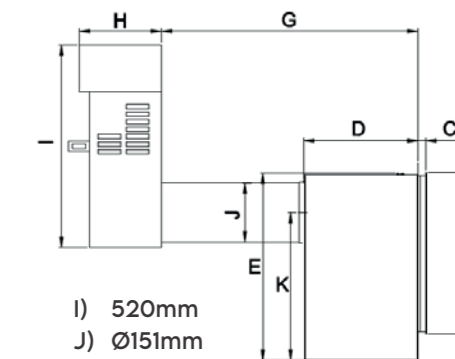
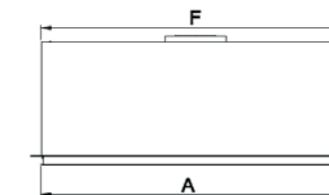

- A) 798mm
- B) 415mm
- C) 18-32mm
- D) 294mm
- E) 480mm
- F) 797mm
- G) 370-660mm
- H) 211mm
- I) 520mm
- J) Ø151mm
- K) 380mm

MANTEL DIMENSIONS

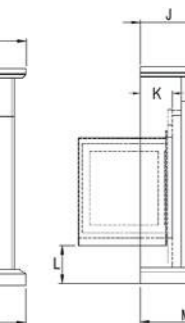
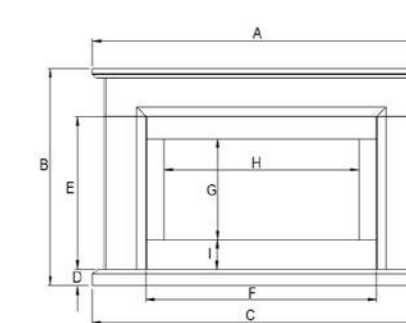

- A) 1370mm
- B) 875mm
- C) 1370mm
- D) 60mm
- E) 614mm
- F) 928mm
- J) 225mm
- K) 155mm
- L) 105mm
- M) 340mm
- G) 406-408mm
- H) 790-792mm
- I) 119mm

RAVEL 600 | (Asti 600 Suite) Limestone



Ravel 600 Edge trim, installed into the As 600 Limestone Suite

CONTROL



Slide

FUEL BED



Log

FUEL



Natural Gas



LPG Propane

WATCH VIDEO



Scan QR Code

FLUE OPTIONS



Brick Chimney



Pre-Fabricated

GAS CONSUMPTION - NATURAL

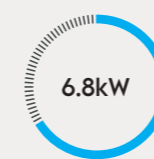

Heat Input (High)

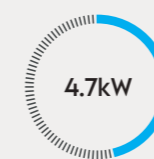

Heat Input (Low)



Heat Output (High)

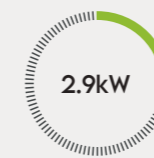

Heat Output (Low)

74% EFFICIENCY

ENERGY EFFICIENCY CLASS E

GAS CONSUMPTION - LPG

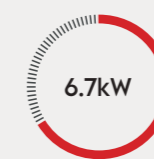

Heat Input (High)

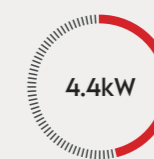

Heat Input (Low)



Heat Output (High)

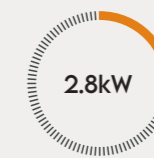

Heat Output (Low)

76% EFFICIENCY

Dimensions

EDGE

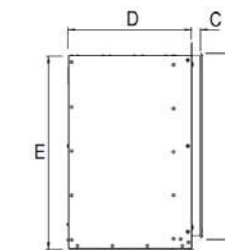
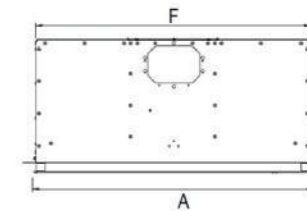

A) 598mm
B) 598mm
C) 18-32mm
D) 280mm

E) 665mm
F) 597mm

EDGE TRIM ONLY

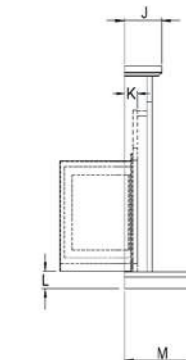
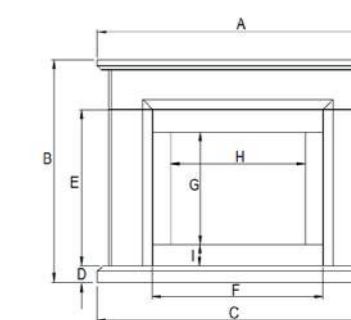

A) 1210mm
B) 1032mm
C) 1220mm
D) 60mm
E) 742mm
F) 780mm
G) 590mm
H) 588mm
I) 72mm
J) 145mm
K) 45mm
L) 60mm
M) 380mm

Note: The Asti 600 Limestone suite is only available to suit the Edge style trim as shown.

The Ravel 600 joins the family of Ravel products from Wildfire. This glass fronted gas fire is suitable for both class 1 and class 2 flues.

The Ravel 600 features the latest in under-log burner technology is sure to impress with its stunning fuel bed layout. The unique burner system allows the fire to be turned to low whilst still retaining an impressive flame picture.

Shown here in the Asti 600 Limestone surround, installed with the sleek Edge trim, for the trimless look. The Ravel 600 will fit nearly all masonry fireplace openings.

RAVEL 600 | (Amalfi Suite) Micro marble



Ravel 600 Edge trim, installed into the Amalfi 600 micro marble Suite

CONTROL



Slide

FUEL BED



Log

FUEL



Natural Gas



LPG Propane

WATCH VIDEO



Scan QR Code

FLUE OPTIONS



Brick Chimney



Pre-Fabricated

GAS CONSUMPTION - NATURAL

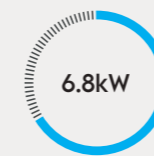

Heat Input (High)

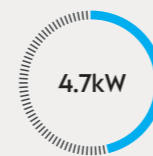

Heat Input (Low)



Heat Output (High)

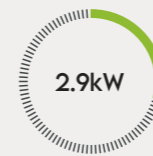

Heat Output (Low)

74% EFFICIENCY

ENERGY EFFICIENCY CLASS E

GAS CONSUMPTION - LPG

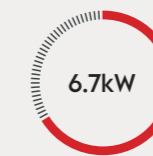

Heat Input (High)

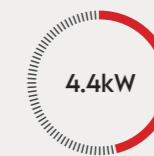

Heat Input (Low)



Heat Output (High)

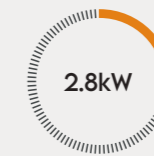

Heat Output (Low)

76% EFFICIENCY

Dimensions

EDGE TRIM

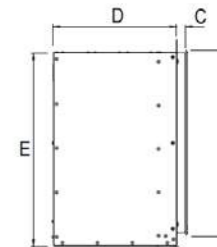
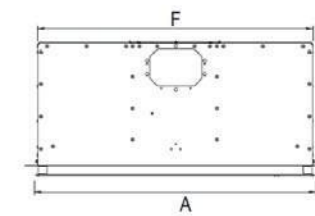

A) 598mm

B) 598mm

C) 18-32mm

D) 280mm

E) 665mm

F) 597mm

MANTEL FINISH

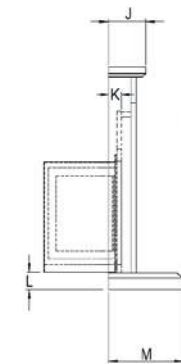
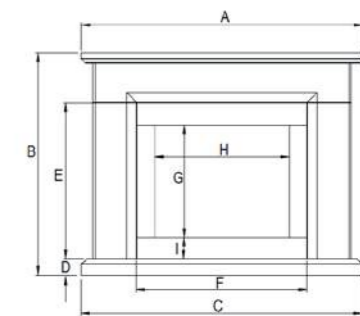

A) 1270mm

B) 1080mm

C) 1270mm

D) 65mm

E) 765mm

F) 873mm

G) 590mm

H) 590mm

I) 72mm

J) 170mm

K) 50mm

L) 65mm

M) 300mm

Note: The Amalfi marble suite is only available to suit the Edge style trim as shown.

The Ravel 600 joins the family of Ravel products from Wildfire. This glass fronted gas fire is suitable for both class 1 and class 2 flues.

The Ravel 600 features the latest in under-log burner technology is sure to impress with its stunning fuel bed layout. The unique burner system allows the fire to be turned to low whilst still retaining an impressive flame picture.

Shown here in the Amalfi 600 micro marble surround, installed with the sleek Edge trim, for the trimless look. The Ravel 600 will fit nearly all masonry fireplace openings.

RAVEL 600 | HIW



Ravel 600 Edge trim, installed as HIW.
Inset: Ravel 600 shown with standard (wide) trim.

CONTROL



Slide

FUEL BED



Log

FUEL



Natural Gas



LPG Propane

WATCH VIDEO



Scan QR Code

FLUE OPTIONS



Brick Chimney



Pre-Fabricated

GAS CONSUMPTION - NATURAL

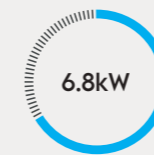

Heat Input (High)



Heat Input (Low)



Heat Output (High)

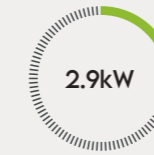

Heat Output (Low)

74% EFFICIENCY

ENERGY EFFICIENCY CLASS E

GAS CONSUMPTION - LPG

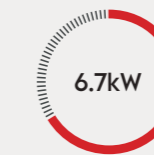

Heat Input (High)



Heat Input (Low)



Heat Output (High)

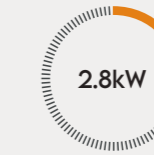

Heat Output (Low)

76% EFFICIENCY

Dimensions

EDGE

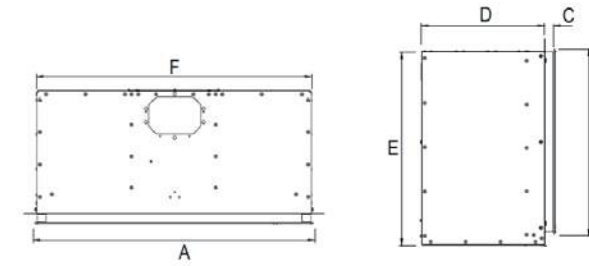

A) 598mm
B) 598mm
C) 18-32mm
D) 280mm
E) 665mm
F) 597mm

STANDARD

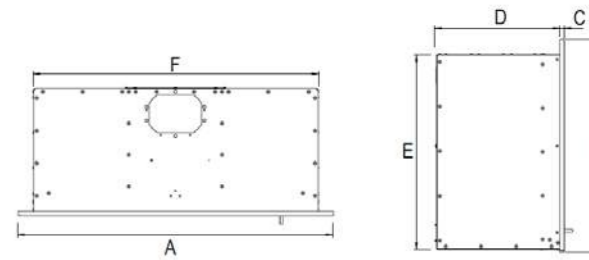

A) 747mm
B) 747mm
C) 10mm
D) 280mm
E) 665mm
F) 597mm

The Ravel 600 joins the family of Ravel products from Wildfire. This glass fronted gas fire is suitable for both class 1 and class 2 flues.

The Ravel 600 features the latest in under-log burner technology is sure to impress with its stunning fuel bed layout. The unique burner system allows the fire to be turned to low whilst still retaining an impressive flame picture.

Shown here installed as a Hole in the Wall fire with the sleek Edge trim, for the trimless look. The Ravel 600 will fit nearly all masonry fireplace openings.

RAVEL 600BF

(Asti BF 600 Suite) Limestone



HE



CONTROL



Slide

FUEL BED



Log

FUEL



Natural Gas

FLUE OPTIONS



Balanced Flue

WATCH VIDEO



Scan QR Code

GAS CONSUMPTION

76% EFFICIENCY

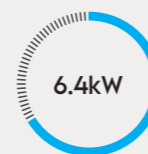

Heat Input (High)

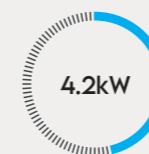

Heat Input (Low)



Heat Output (High)

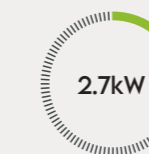

Heat Output (Low)

ENERGY EFFICIENCY CLASS E

The Ravel 600 BF is a new product designed to operate in buildings without chimneys or flues. This product follows in the footsteps of its extremely successful sister model the Ravel 600 (conventional flue).

The Ravel 600BF incorporates all of the features available on other Ravel products including underlog burner technology, turndown function allowing the rear burners to be turned off to retain flame picture on low and a reliable and easy to use slide control system.

Shown here in the Asti 600BF Limestone suite, this fire is only available with the Edge trim, for the sleek trimless look (supplied with product).

Dimensions

EDGE

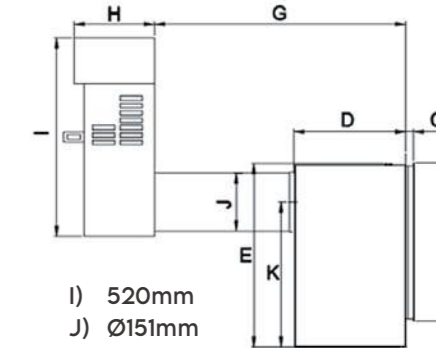
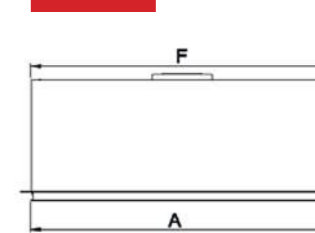

- A) 598mm
- B) 598mm
- C) 18-32mm
- D) 294mm
- E) 662mm
- F) 597mm
- G) 370-660mm
- H) 211mm
- I) 520mm
- J) Ø151mm
- K) 563mm

MANTEL DIMENSIONS

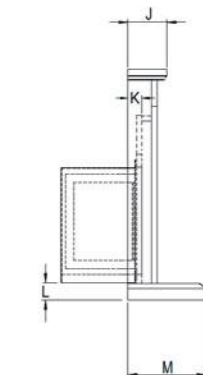
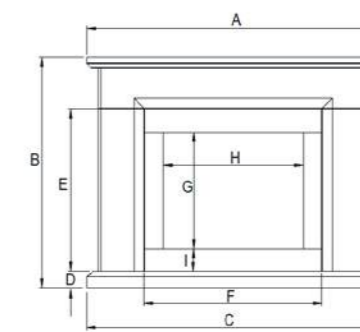

- A) 1210mm
- B) 1032mm
- C) 1220mm
- D) 60mm
- E) 742mm
- F) 780mm
- G) 590mm
- H) 588mm
- I) 72mm
- J) 255mm
- K) 155mm
- L) 60mm
- M) 380mm

RAVEL 550 HE

(Emelia Suite) Micro marble



HE

Ravel 550 HE shown with Contemporary Black Nickel/Black trim, Installed into the Emelia suite in white.

This fire requires a fireplace suite with a 3" rebate and a back panel opening of a specific size. Talk to your retailer for full details.

FLUE OPTIONS



CONTROL



FUEL BED



FUEL



RAVEL 550 HE TRIM OPTIONS

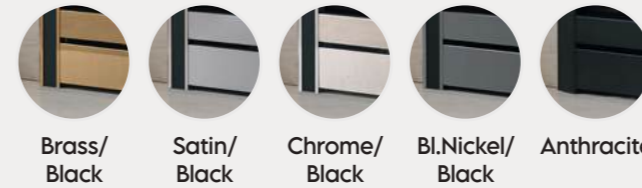

SLIDE LEVER OPTIONS



GAS CONSUMPTION

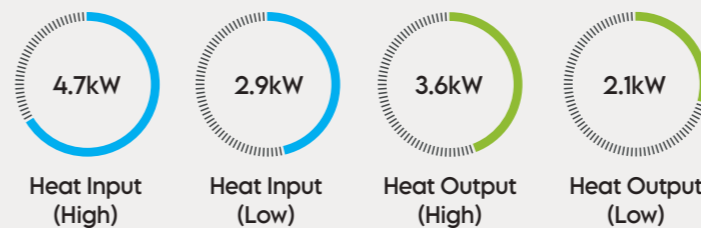

85% EFFICIENCY

STANDARD MANTEL FINISH OPTIONS



ENERGY EFFICIENCY CLASS D

WATCH VIDEO



Scan QR Code

DIMENSIONS

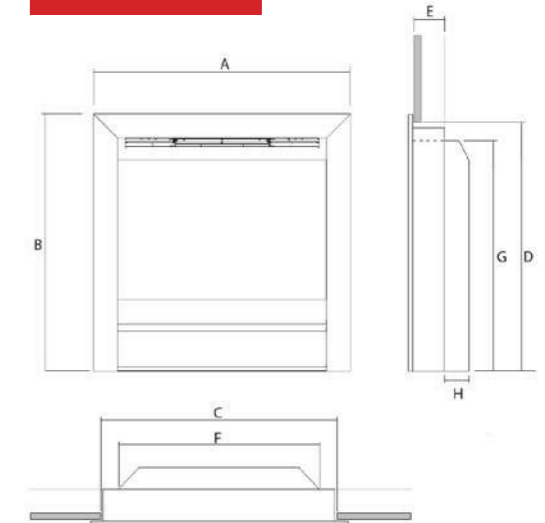

- A) 614mm Trim Width
- B) 611mm Trim Height
- C) 560mm-580mm Back Panel Opening Width
- D) 585mm-600mm Back Panel Opening Height
- E) 76mm Mantel Rebate
- F) 406mm Fire Width at Builders Opening
- G) 565mm Fire Height at Builders Opening
- H) 117mm Fire Depth into Builders Opening

MANTEL DIMENSIONS

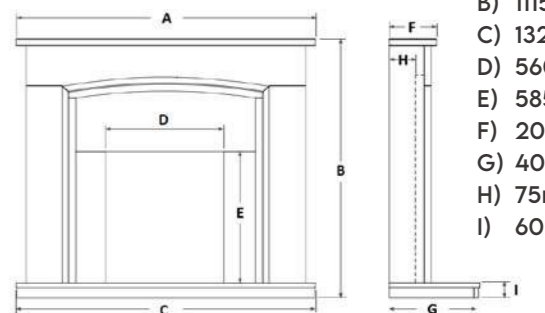

- A) 1320mm
- B) 1115mm
- C) 1320mm
- D) 560-580mm
- E) 585-600mm
- F) 200mm
- G) 400mm
- H) 75mm
- I) 60mm

The Ravel 550 log fire is a revolutionary product.

This wide format glass fronted gas appliance has the appeal of a European fire but the benefit of fitting into a standard 16" x 22" chimney builders opening. The fire incorporates under-log burners to provide the most realistic effect, with a unique turndown feature allowing the rear burners to be turned off independently to keep the flame picture alive when running on low.

This installation requires a back panel with specific opening sizes and a 75mm rebate. Normally an appliance of this stature would require building work and installation of a lintel. Talk to your dealer for full details. The Ravel 550 is supplied with slide control as standard.

RAVEL 550 HE Inset Stove | (Emelia Suite)



HE

Ravel 550 HE shown installed into the Emelia suite in white.

FLUE OPTIONS



Brick Chimney



Pre-Fabricated

CONTROL



Slide

FUEL BED



Log

FUEL



Natural Gas

STOVE HANDLE OPTIONS



Satin



Black

Note: Satin handle is supplied as standard. Black handle is an optional extra.

SLIDE LEVER OPTIONS

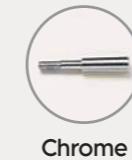

Chrome

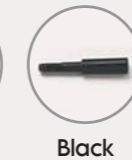

Black

WATCH VIDEO



Scan QR Code

GAS CONSUMPTION

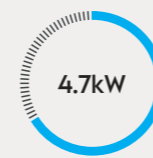

Heat Input (High)

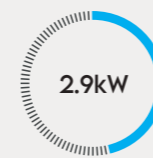

Heat Input (Low)

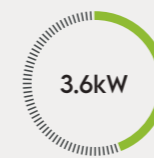

Heat Output (High)

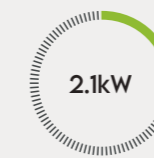

Heat Output (Low)

85% EFFICIENCY

STANDARD MANTEL FINISH OPTIONS

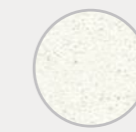

White



*Grey

ENERGY EFFICIENCY CLASS D

DIMENSIONS

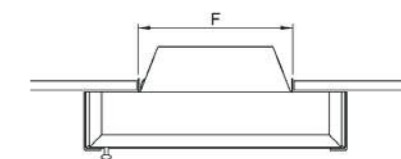
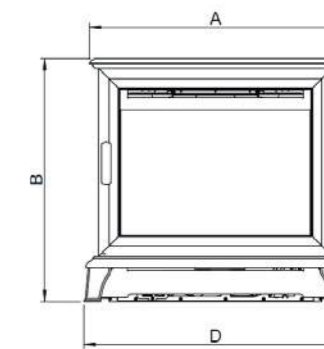

A) 660mm
B) 635mm
C) 144mm

D) 689mm
E) 120mm
F) 403mm

G) 559mm
H) 152mm

MANTEL DIMENSIONS

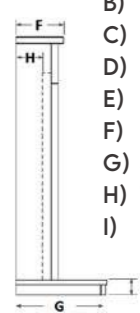
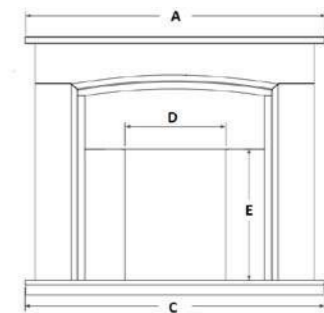

A) 1320mm
B) 1115mm
C) 1320mm
D) 405mm
E) 570mm
F) 200mm
G) 400mm
H) 75mm
I) 60mm

The Ravel 550 log fire is a revolutionary product.

The fire incorporates under-log burners to provide the most realistic effect, with a unique turndown feature allowing the rear burners to be turned off independently to keep the flame picture alive when running on low.

This 22" appliance installs into any standard 16" x 22" back panel and is shrouded with an aluminium high definition stove trim, so it's a perfect upgrade from your old 16" fire without changing the fireplace. Talk to your dealer for full details. The Ravel 550 is supplied with slide control as standard.

RAVEL 400 HE | (Salvador Suite)



Ravel HE Log shown with Black Nickel / Chrome trim, installed into the Salvador White Suite

FLUE OPTIONS



CONTROL



FUEL BED



FUEL



RAVEL TRIM OPTIONS

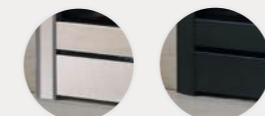

Bl.Nickel/Chrome Anthracite

SLIDE LEVER OPTIONS



Chrome Black Nickel Black Ezi-Grip

MANTEL FINISH

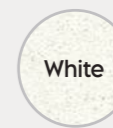

White

GAS CONSUMPTION

81% EFFICIENCY

NATURAL

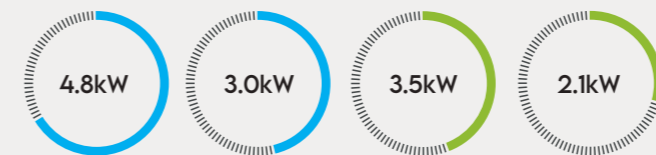

Heat Input (High) Heat Input (Low) Heat Output (High) Heat Output (Low)

ENERGY EFFICIENCY CLASS D

GAS CONSUMPTION

80% EFFICIENCY

LPG

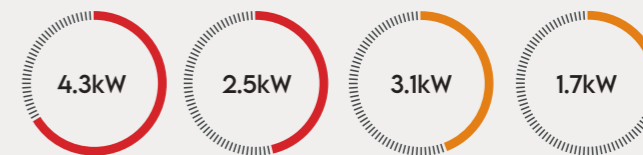

Heat Input (High) Heat Input (Low) Heat Output (High) Heat Output (Low)

ENERGY EFFICIENCY CLASS E

DIMENSIONS

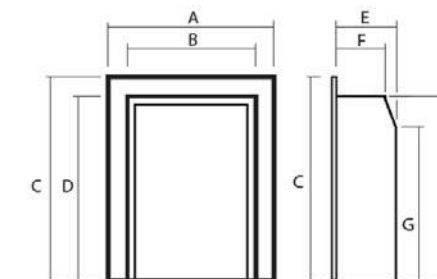

- A) 512mm
- B) 403mm
- C) 610mm
- D) 555mm
- E) 197mm
- F) 186mm
- G) 502mm

MANTEL DIMENSIONS

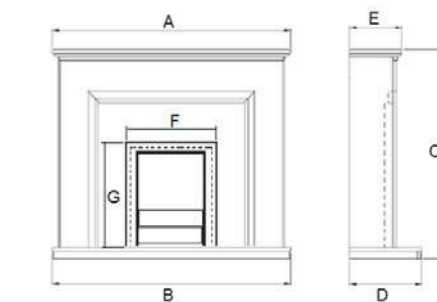

- A) 1370mm
- B) 1370mm
- C) 1160mm
- D) 400mm
- E) 230mm
- F) 512mm
- G) 610mm

The Ravel 400 HE Log 16"x 22" is a high efficiency glass fronted fire suitable for class 1 and class 2 flues.

The Ravel HE Log is sure to impress, with its under log burners and stunning fuel bed layout. The unique burner system allows the fire to be turned to low whilst still retaining an impressive flame height.

This fire is available with two trim styles, the Black Nickel and Chrome or the striking Anthracite version.

Also available as 4 sided HIW. See pages 42 & 43.

RAVEL 400 Inset Stove | (Salvador Suite)



Ravel HE Inset Stove shown installed into the Salvador Suite (white).

HE

FLUE OPTIONS



See page 45 for appliance dims

CONTROL



FUEL BED



FUEL



STOVE HANDLE OPTIONS

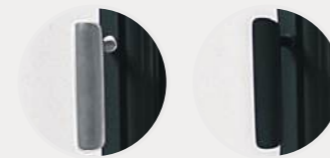

Satin

Black

Note: Satin handle is supplied as standard. Black handle is an optional extra.

SLIDE LEVER OPTIONS

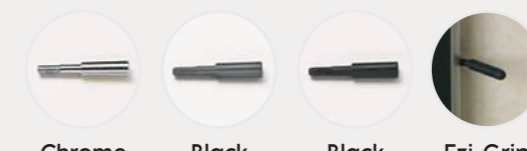

Chrome

Black Nickel

Black

Ezi-Grip

GAS CONSUMPTION

81% EFFICIENCY

NATURAL



Heat Input (High)

Heat Input (Low)

Heat Output (High)

Heat Output (Low)

ENERGY EFFICIENCY CLASS D

GAS CONSUMPTION

80% EFFICIENCY

LPG

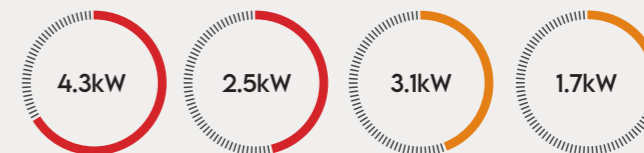

Heat Input (High)

Heat Input (Low)

Heat Output (High)

Heat Output (Low)

ENERGY EFFICIENCY CLASS E

DIMENSIONS

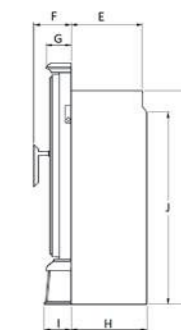
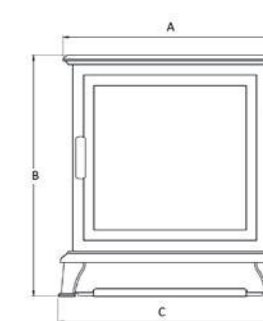

A) 512mm F) 97mm
B) 630mm G) 65mm
C) 584mm H) 198mm
D) 557mm I) 70mm
E) 186mm J) 502mm

*Note: For mantel details see page 39.

The Ravel 400 can now also be supplied as a slide control inset stove fronted product.

Employing the Ravel stove clean lines, our engineers have developed an aluminium, light weight trim which will transform your Ravel 400 into an inset gas log stove. Offering all of the features and benefits of the Ravel 400 product this log burner will never fail to impress.



RAVEL 400 HE | (HIW)

HE

FLUE OPTIONS

- Brick Chimney
- Pre-Fabricated

CONTROL

- Slide

FUEL BED

- Log

FUEL

- Natural Gas
- LPG Propane

RAVEL TRIM OPTIONS

- Bl.Nickel/Chrome
- Anthracite

SLIDE LEVER OPTIONS

- Chrome
- Black Nickel
- Black
- Ezi-Grip

GAS CONSUMPTION



NATURAL

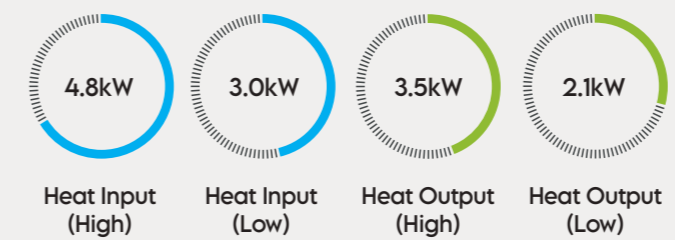

ENERGY EFFICIENCY CLASS D

GAS CONSUMPTION



LPG

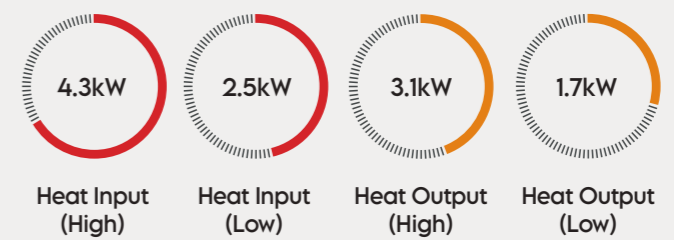

ENERGY EFFICIENCY CLASS E

DIMENSIONS

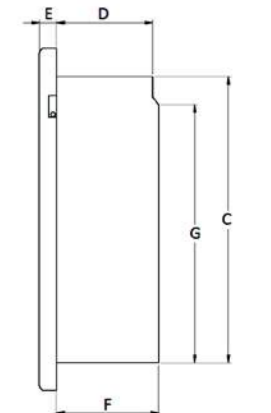
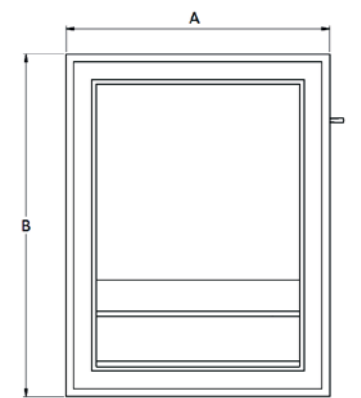

- A) 510mm
- B) 665mm
- C) 556mm
- D) 186mm
- E) 33mm
- F) 198mm
- G) 502mm

The Ravel 400 can now also be supplied as a slide control hole in the wall product.

The extremely successful black nickel and chrome frame has been used to create this four sided design, allowing a space saving and economical solution for your living room. Offering all of the features and benefits of the Ravel 400 product this log burner will never fail to impress.

RAVEL 400 HE | Balanced Flue



Ravel 400 BF shown with Black Nickel / Chrome trim. Featuring Salvador micromarble fireplace in white (see page 39 for details)

FLUE OPTIONS



CONTROL



FUEL BED



FUEL



RAVEL TRIM OPTIONS



Bl.Nickel/Chrome Anthracite Inset Stove (see page 40) HIW (see page 42)

SLIDE LEVER OPTIONS



Chrome Black Nickel Black Ezi-Grip

GAS CONSUMPTION

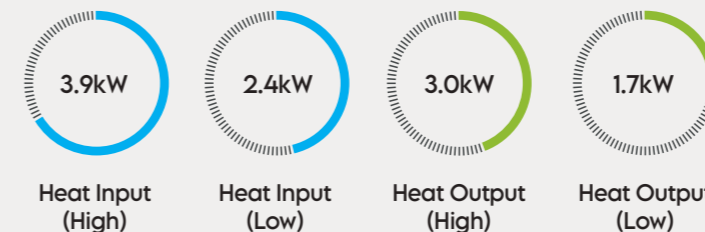

83% EFFICIENCY

STANDARD MANTEL FINISH OPTIONS

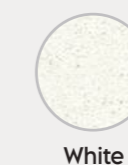

ENERGY EFFICIENCY CLASS D

DIMENSIONS

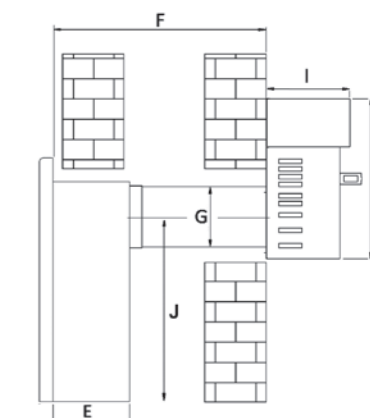
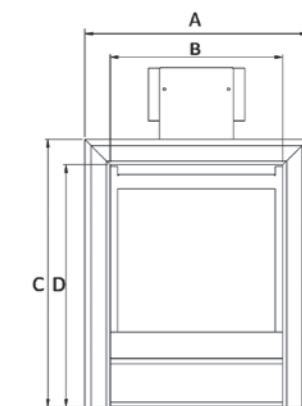

- A) 510mm
- B) 394mm
- C) 611mm
- D) 553mm
- E) 197mm
- F) 290-580mm
- F*) 290-780mm
- G) Ø152mm
- H) 400mm
- I) 206mm
- J) 463.5mm

Note: F dimensions apply to optional longer flue kit (F-181XX2TKS)

The Ravel 400 is now available in balanced flue format. With the same intricately detailed logs and unique underlog burners this appliance is the perfect solution for economic heating in homes without a flue.

The product is available with the two standard Ravel 16" trims in Black Nickel and Chrome or Anthracite but can also be configured to be installed as a hole in the wall (HIW) see page 42, or as an inset stove—see page 40. The Ravel 400BF also employs the same controllability as the conventional flue version, allowing the fire to be turned to a low setting whilst still retaining an impressive flame height.

RAVEL 400C Gas Stove



Ravel Gas Stove shown inset with black handle and control lever. Available as optional extras.



CONTROL



Slide

FUEL BED



Log

FUEL



Natural Gas



LPG Propane

WATCH VIDEO



Scan QR Code

STOVE HANDLE OPTIONS



Satin



Black

Note: Satin handle is supplied as standard. Black handle is an optional extra.

FLUE OPTIONS



Brick Chimney



Pre-Fabricated



Pre-Cast

GAS CONSUMPTION - NATURAL

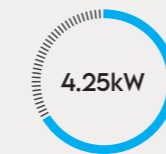

Heat Input (High)

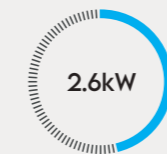

Heat Input (Low)

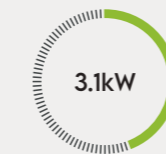

Heat Output (High)

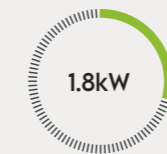

Heat Output (Low)

82% EFFICIENCY

ENERGY EFFICIENCY CLASS D

GAS CONSUMPTION - LPG



Heat Input (High)

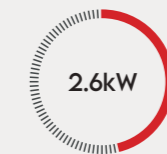

Heat Input (Low)



Heat Output (High)

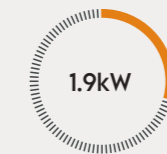

Heat Output (Low)

84% EFFICIENCY

DIMENSIONS

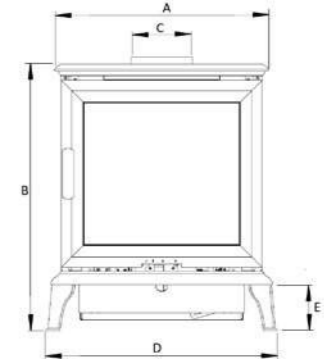

- A) 464mm
- B) 584mm
- C) 127mm
- D) 502mm
- E) 100mm
- F) 289mm
- G) 315mm
- H) 67mm
- I) 515mm

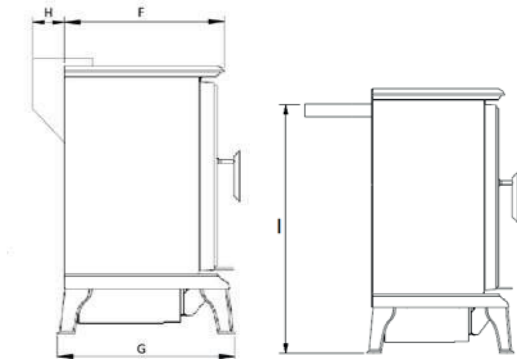

*Precast flue/Rear vent kit is ordered separately.

Note: The Ravel 400C is now also available in Balanced Flue. See pages 50-51

The Ravel Stove is a stunning addition to any open fireplace. Based on the proven under-log burner system of the highly successful Ravel gas fire.

This gas stove version features crisp and clean lines only possible with the light weight aluminium extrusion employed in this design. Suitable for use with Class 1, Class 2 and precast flues.* The unique burner system allows the fire to be turned to low whilst still retaining an impressive flame effect.

RAVEL 400T Gas Stove | Asti 750 Chamber Suite



HE

CONTROL



Slide

FUEL BED



Log

FUEL



Natural Gas



LPG Propane

WATCH VIDEO



Scan QR Code

FLUE OPTIONS



Brick Chimney



Pre-Fabricated



Pre-Cast

GAS CONSUMPTION - NATURAL

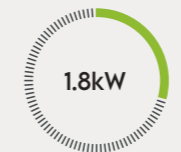
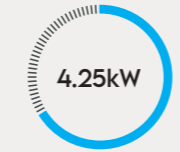

82% EFFICIENCY

ENERGY EFFICIENCY CLASS D

GAS CONSUMPTION - LPG

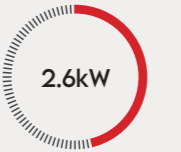
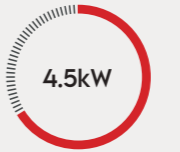

84% EFFICIENCY

DIMENSIONS

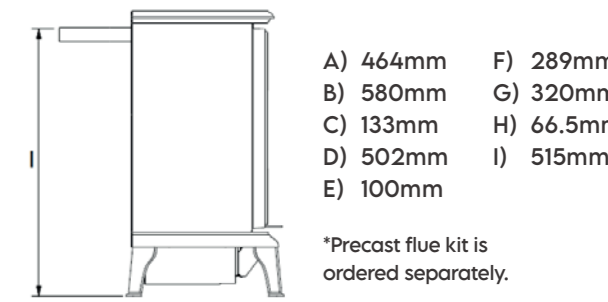
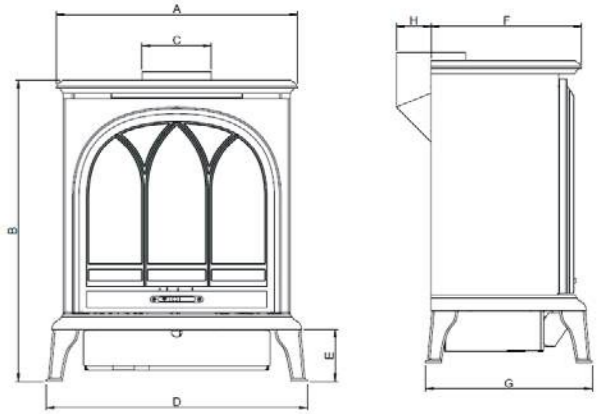

- A) 464mm
- B) 580mm
- C) 133mm
- D) 502mm
- E) 100mm
- F) 289mm
- G) 320mm
- H) 66.5mm
- I) 515mm
- J) 100mm

*Precast flue kit is ordered separately.

CHAMBER DIMENSIONS

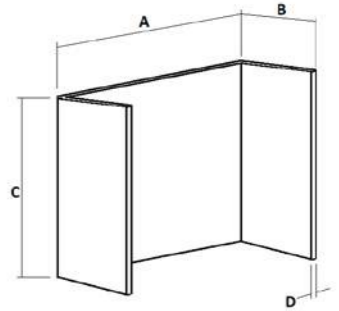

- A) 1020mm
- B) 450mm
- C) 1000mm
- D) 25mm

The Asti Chamber Suite can be ordered as a package with either the 400C or 400T gas stoves.

The mantel dimensions can be found on page 15. The package includes mantel, hearth, chamber and back hearth.

The Ravel 400T gas stove is a beautiful timeless addition to any room. The product features all the benefits of the proven Ravel burner system.

The stove is easy to control with a simple slide lever located below the glass screen. It features a light weight aluminium casting which provides crisp and clean lines, aesthetics are at the heart of this product. The fire incorporates under-log burners to provide the most realistic effect, with a unique turndown feature allowing the rear burners to be turned off independently to keep the flame picture alive when running on low. And, just like the Ravel 400C, it can be installed into Class 1, Class 2 and precast flues*. The Ravel 400T is also available as a balanced flue model (see pages 50-51).

RAVEL 400 BF Gas Stoves



Images shown with optional false vertical flue kit installed.



Inset shows Ravel 400C BF

CONTROL



Slide

FUEL BED



Log

FUEL



Natural Gas

WATCH VIDEO



Scan QR Code

FLUE OPTIONS



Balanced Flue

STOVE HANDLE OPTIONS

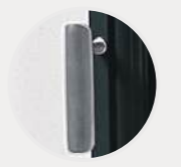

Satin

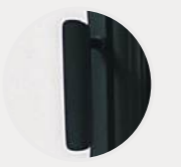

Black

Note: Satin handle is supplied as standard on 400C models. Black handle is an optional extra.

GAS CONSUMPTION

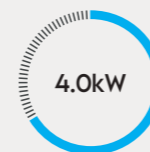

Heat Input (High)

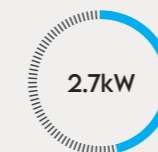

Heat Input (Low)



Heat Output (High)

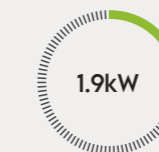

Heat Output (Low)

83% EFFICIENCY

ENERGY EFFICIENCY CLASS D

Dimensions

400T BF

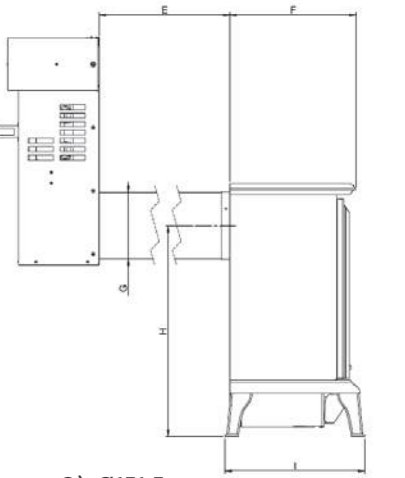
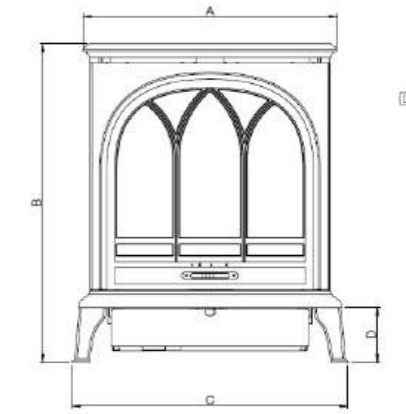

- A) 464mm
- B) 580mm
- C) 502mm
- D) 100mm
- E) 290-580mm
- F) 289mm
- G) Ø151.5mm
- H) 483.5mm
- I) 320mm

400C BF

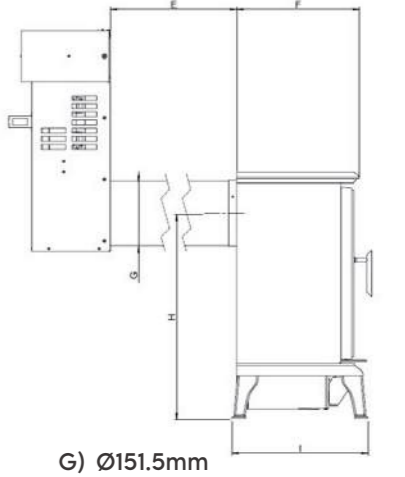
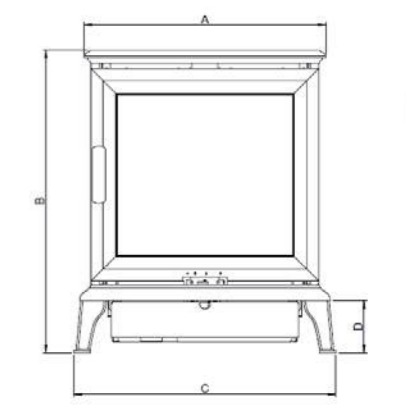

- A) 464mm
- B) 580mm
- C) 502mm
- D) 100mm
- E) 290-580mm
- F) 289mm
- G) Ø151.5mm
- H) 483.5mm
- I) 320mm

Note: A vertical false flue kit is also available as an optional extra.

The hugely successful Ravel 400 gas stoves will now be available as Balanced Flue versions. Both the 400C and 400T models can now be installed into a property with no chimney.

The products feature all the benefits of the Ravel gas fire range, with under-log burners and a turndown function which keeps the flame picture alive on low setting. A false vertical flue kit is also available as an option to create the authentic look of a chimney installation. The Asti 750 Chamber Suite is also available to order as a complete package – see page 49 for full details.

BF960SL

Balanced Flue



FLUE OPTION



CONTROL



FUEL BED



FUEL



GAS CONSUMPTION

86% EFFICIENCY

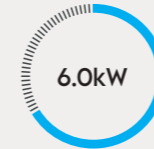

Heat Input (High)

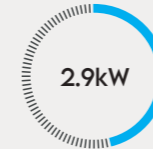

Heat Input (Low)



Heat Output (High)



Heat Output (Low)

ENERGY EFFICIENCY CLASS C

The BF960SL balanced flue gas fire is suitable for homes without a chimney.

This versatile and efficient slimline hole in the wall fire can be installed onto any outside wall of the home and generates a contemporary and stylish centrepiece for the room. This appliance can be installed directly into a cavity wall yet provides probably the deepest fuel bed effect for a product of its type. Coupled with a reflective black glass lining, this gas fire delivers the ultimate dancing flame effect and ceramic log layout.

Dimensions

TRIM

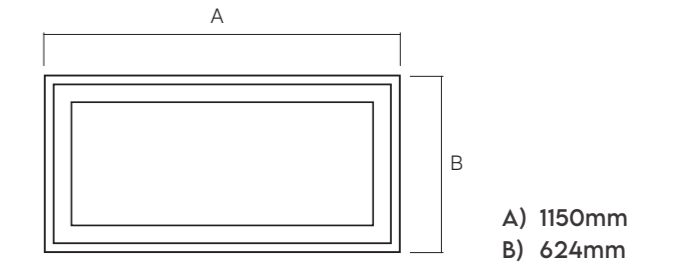

APPLIANCE

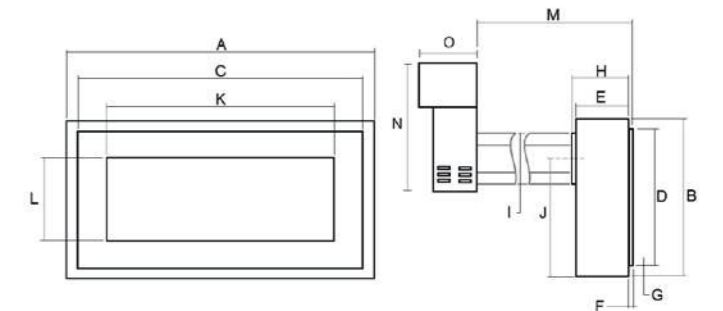

- A) 1198mm
- B) 666mm
- C) 1138mm
- D) 608mm
- E) 174mm
- F) 13mm
- G) 29mm
- H) 183mm
- I) 151mm
- J) 523mm
- K) 862mm
- L) 332mm
- M) 270mm - 725mm
- N) 400mm
- O) 206mm

Thermes

Balanced Flue

HE

“The balanced flue fire that **really** delivers”



Thermes shown with Profile Contemporary Satin/Black trim. Featured with an Elgin & Hall Roesia surround in white Micro Marble

FLUE OPTIONS



Balanced Flue

CONTROLS



Slide



Manual Electronic

FUEL BED



Coal

FUEL



Natural Gas

STANDARD TRIM OPTIONS

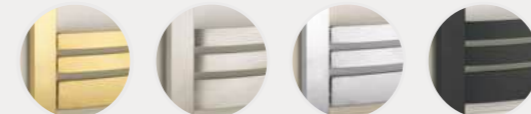

Brass Satin Chrome Black

Contemporary trim includes front bars. Trims can be purchased without front bars. For more details see page 74.

PROFILE TRIM OPTIONS

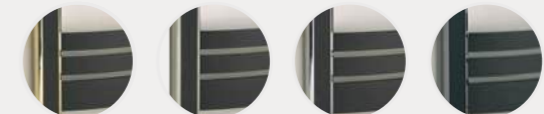

Brass/Black Profile Satin/Black Profile Chrome/Black Profile Bl.Nickel/Black Profile

CREATIVE TRIM OPTIONS

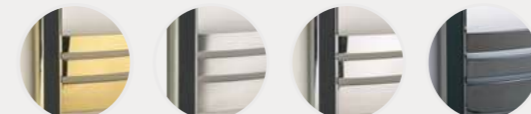

Brass/Black Satin/Black Chrome/Black Bl.Nickel/Black

SLIDE LEVER OPTION

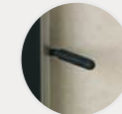

Ezi-Grip

ENERGY EFFICIENCY CLASS C

GAS CONSUMPTION

86% EFFICIENCY

SLIDE CONTROL

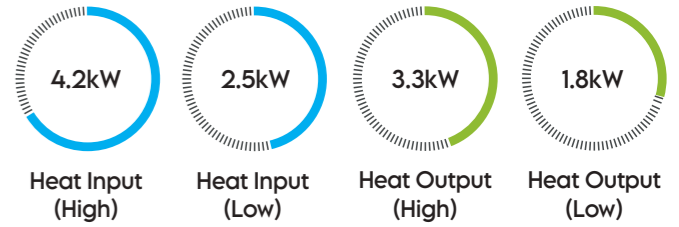

MANUAL CONTROL

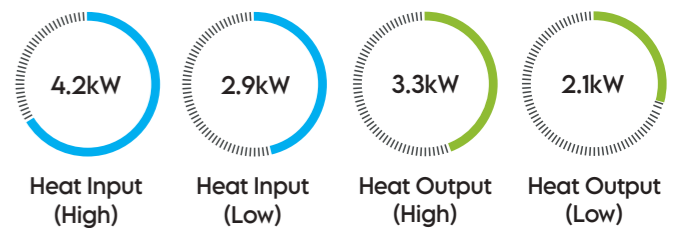

DIMENSIONS

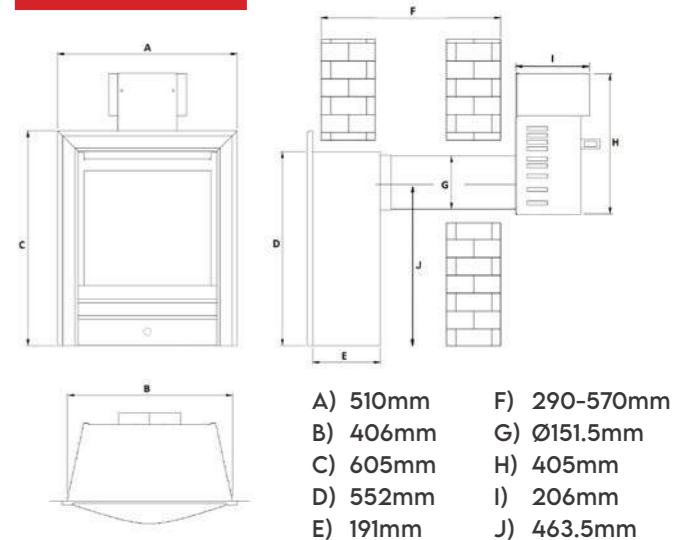

The Thermes is our high efficiency balanced flue gas appliance.

If you have no flue or chimney in your home you will need a balanced flue gas fire. The Thermes is a room sealed high efficiency gas fire that really delivers. This fire flues through an external wall and can be installed in most new or existing fireplaces.

Remember, once you have chosen your appliance, you can decide how it looks by selecting trim and fret options. See the trim options below and in more detail on page 74.

Ellipsis



The Ellipsis 'Hole in the wall' with Chrome/Black trim. Open fronted in pebble (inset)



FLUE OPTIONS



CONTROLS



FUEL



FUEL BEDS **Open fronted only



ELLIPSIS TRIM OPTIONS



4 Sided Satin/Black

4 Sided Chrome/Black

Satin/Black

Chrome/Black

Also available in 3 sided for hearth mounted version

This beautifully styled hole in the wall appliance produces a powerful output.

Its warmth will transform your living environment. The Ellipsis is suitable for Class 1 and Class 2 flue types and is available in Coal or Pebble**. The Ellipsis is available in open fronted or glass fronted HE format. The Ellipsis open fronted has a pebble option. This product is only available as manual control.

The Wildfire Ellipsis combines style, efficiency and space saving to provide the ultimate solution for an open fronted gas or glass fronted fire. If you are looking for realism coupled with powerful heat whilst retaining efficiency then this is the product for you.

GAS CONSUMPTION

For inputs and outputs and efficiency classes refer to the relevant pages as below:

OPEN FRONTED
(REFER TO MONTESE - PAGE 71)

GLASS FRONTED
(REFER TO CRESSIDA - PAGE 65)

BALANCED FLUE
(REFER TO THERMES - PAGE 55)

Dimensions

OPEN FRONTED

- A) 512mm
- B) 403mm
- C) 660mm (HIW)
- D) 553mm
- E) 173mm
- F) 104mm
- G) 358mm

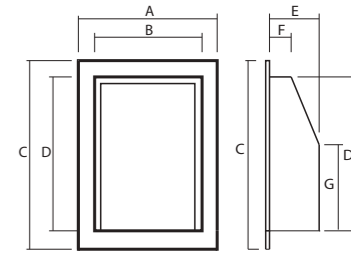

GLASS FRONTED

- A) 512mm
- B) 403mm
- C) 660mm (HIW)
- D) 553mm
- E) 198mm
- F) 174mm
- G) 358mm

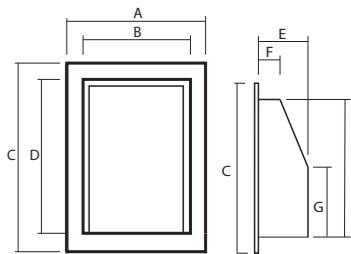

BALANCED FLUE

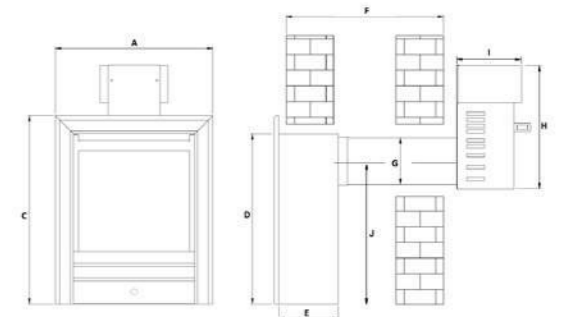

- A) 510mm
- B) 406mm
- C) 605mm
- D) 552mm
- E) 191mm
- F) 290-570mm
- G) Ø151.5mm
- H) 405mm
- I) 206mm
- J) 463.5mm

HE

NOTE: GRANITE SLIPS **NOT** INCLUDED

HE 950L

(Asti Suite)



HE

FLUE OPTIONS



*When ordered as PCF model

CONTROL



Slide

FUEL BED



Log

FUEL



Natural Gas

GAS CONSUMPTION

75% EFFICIENCY

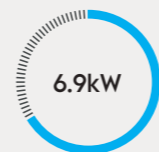

Heat Input (High)

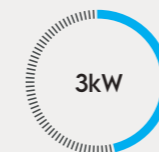

Heat Input (Low)

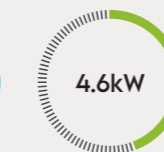

Heat Output (High)

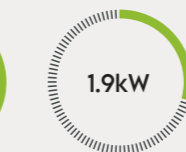

Heat Output (Low)

The new HE950L (STD & PCF) is the perfect appliance to bring your fireplace to life.

Just like the HE900, its predecessor, this fire fits into your standard 16" x 22" builders opening or precast flue if the PCF version is ordered. No building work, lintels, mess or costly installation. The fabric of your home will remain intact but you will benefit from a landscape, large format gas fire with beautifully crafted logs and colourful dancing flames. Ask your retailer for the different fireplace design options available with the HE950L, they will be able to deliver a suite to compliment the style of your living room.

DIMENSIONS

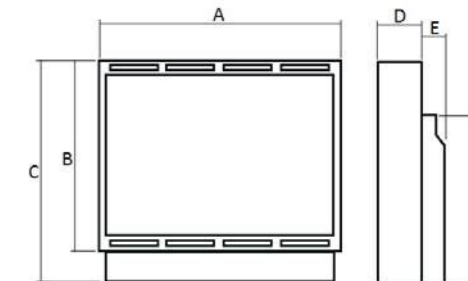

A) 800mm D) 165mm (Standard) E) 55mm (PCF)
 B) 520mm D) 220mm (PCF) F) 553mm
 C) 620mm E) 110mm (Standard)

MANTEL DIMENSIONS

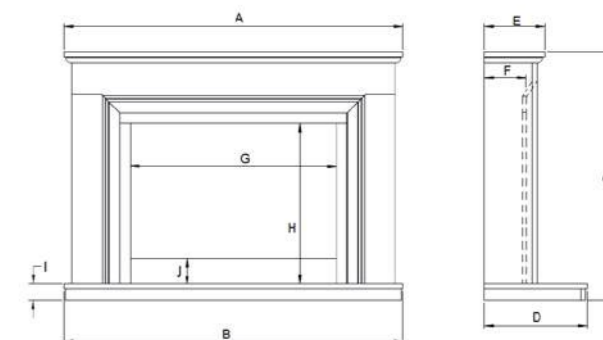

A) 1250mm E) 225mm (Standard) G) 803mm
 B) 1320mm E) 280mm (PCF) H) 624mm
 C) 932mm F) 165mm (Standard) I) 60mm
 D) 400mm F) 220mm (PCF) J) 99mm

HE 950L (Seville Suite)



FLUE OPTIONS



*When ordered as PCF model

CONTROL



Slide

FUEL BED



Log

FUEL



Natural Gas

STANDARD MANTEL FINISH OPTIONS



White

Grey

Seville Suite available with or without Grey inner border.

GAS CONSUMPTION

75% EFFICIENCY

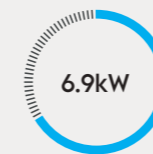

Heat Input (High)



Heat Input (Low)



Heat Output (High)

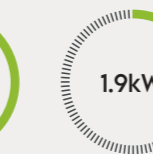

Heat Output (Low)

The new HE950L (STD & PCF) is the perfect appliance to bring your fireplace to life.

Just like the HE900, its predecessor, this fire fits into your standard 16" x 22" builders opening or precast flue if the PCF version is ordered. No building work, lintels, mess or costly installation. The fabric of your home will remain intact but you will benefit from a landscape, large format gas fire with beautifully crafted logs and colourful dancing flames. Ask your retailer for the different fireplace design options available with the HE950L, they will be able to deliver a suite to compliment the style of your living room.

DIMENSIONS

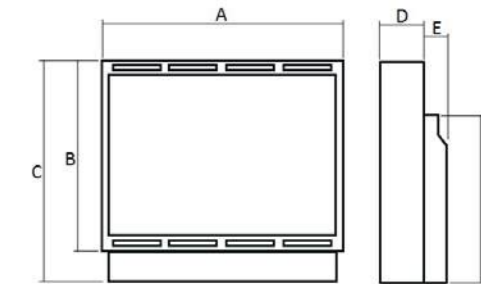

A) 800mm D) 165mm (Standard) E) 55mm (PCF)
 B) 520mm D) 220mm (PCF) F) 553mm
 C) 620mm E) 110mm (Standard)

MANTEL DIMENSIONS

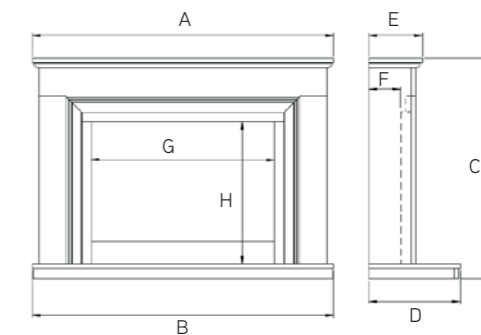

A) 1320mm E) 235mm (Standard) G) 803mm
 B) 1320mm E) 290mm (PCF) H) 624mm
 C) 967mm F) 165mm (Standard)
 D) 400mm F) 220mm (PCF)

HE



HE 900

(Avellino Suite)



Shown as standard version. Also available for Precast Flue.

FLUE OPTIONS



*When ordered as PCF model

CONTROL



Slide

FUEL BED



Log

FUEL



Natural Gas

STANDARD MANTEL FINISH OPTIONS

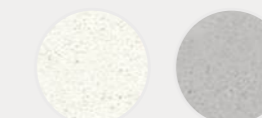

White

Grey

Available with grey inner border - see similar detail on the Seville Suite - page 12.

GAS CONSUMPTION

83% EFFICIENCY

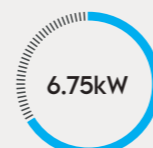

Heat Input (High)



Heat Input (Low)



Heat Output (High)

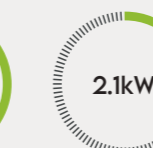

Heat Output (Low)

ENERGY EFFICIENCY CLASS D

DIMENSIONS

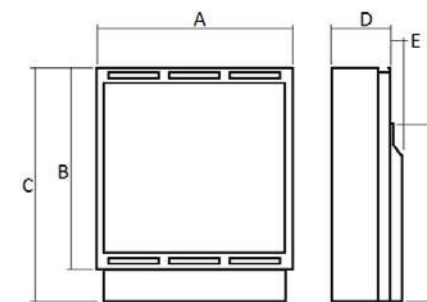

- A) 659mm
- B) 640mm
- C) 740mm
- D) 165mm (Standard)
- D) 220mm (PCF)
- E) 55mm (PCF)
- F) 553mm

MANTEL DIMENSIONS

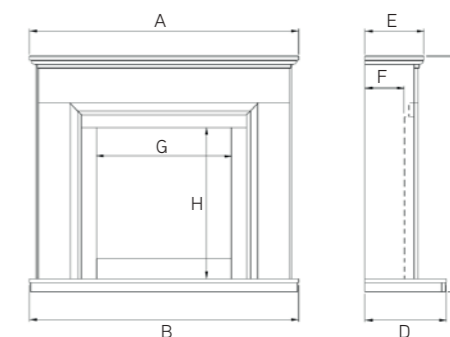

- A) 1320mm
- B) 1320mm
- C) 1159mm
- D) 400mm
- E) 235mm (Standard)
- E) 290mm (PCF)
- F) 165mm (Standard)
- F) 220mm (PCF)
- G) 663mm
- H) 744mm

The HE900 is the flagship model from Wildfire, the ultimate in fireplace technology.

The HE900 gas fire is revolutionary. It has been developed to create a European format appliance with expansive viewing glass that can be installed into a conventional 16" x 22" fireplace opening without any modification, or precast flue where the PCF version is ordered. This patent pending product is designed to fit UK fireplace openings with no need to alter the fabric of the building.

The HE900 features a stunning log and ember bed, easily controlled with a slide operating system which comes as standard. Finally, the ultimate fireplace solution has arrived...

The Avellino micro marble suite is available in white or white with grey border.

Cressida HE



Cressida HE shown with Creative Contemporary Black Nickel/Black trim. Featured with Elgin & Hall Eliana micro marble surround in white.

FLUE OPTIONS



CONTROLS



FUEL BED



FUEL



STANDARD TRIM OPTIONS

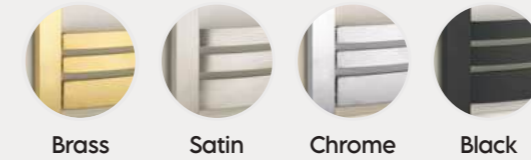

Contemporary trim includes front bars. Trims can be purchased without front bars. For more details see page 74.

PROFILE TRIM OPTIONS

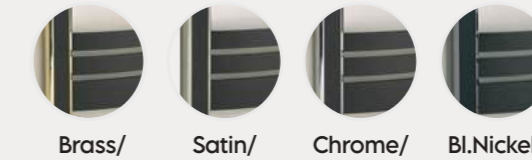

CREATIVE TRIM OPTIONS

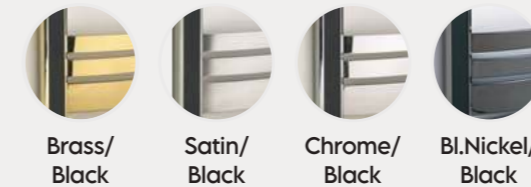

SLIDE LEVER OPTIONS

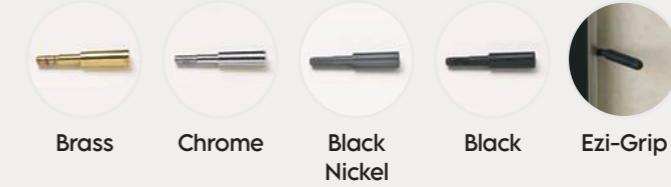

ENERGY EFFICIENCY CLASS C

GAS CONSUMPTION

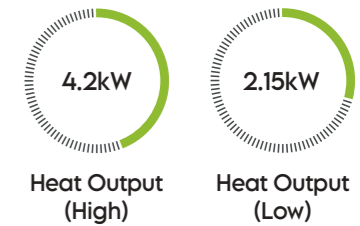
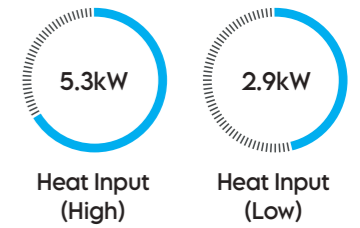

87% EFFICIENCY

DIMENSIONS

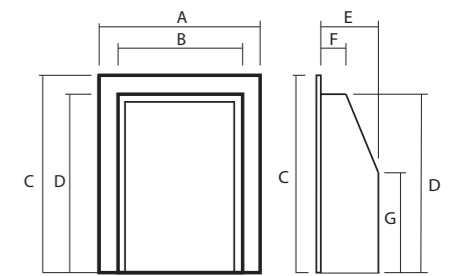

- A) 512mm
- B) 403mm
- C) 607mm
- D) 553mm
- E) 198mm
- F) 174mm
- G) 358mm

The Cressida HE is a high efficiency glass fronted appliance suitable for Class 1 and Class 2 flues.

The most powerful gas fire in the Wildfire range, with its deep bed and powerful output this appliance provides the ultimate in performance and style.

The flagship Cressida HE is supplied in either manual or slide control. The slide control features the latest patent pending Direct Slide technology. Remember, once you have chosen your appliance, you can decide how it looks by selecting trim and fret options. See the trim options below and in more detail on page 74.

Pesaro HE



Pesaro HE shown with Black Contemporary trim. Featured with Elgin & Hall Elento micro marble surround in white & grey.

FLUE OPTIONS



CONTROL



FUEL BED



FUEL



STANDARD TRIM OPTIONS

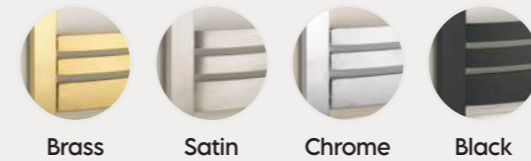

Contemporary trim includes front bars. Trims can be purchased without front bars. For more details see page 74.

PROFILE TRIM OPTIONS

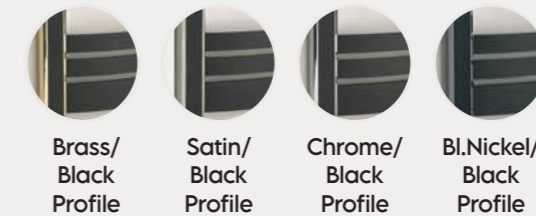

CREATIVE TRIM OPTIONS



SLIDE LEVER OPTIONS

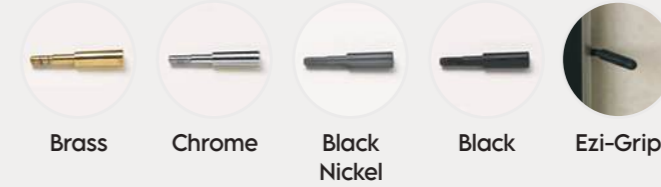

ENERGY EFFICIENCY CLASS D

GAS CONSUMPTION

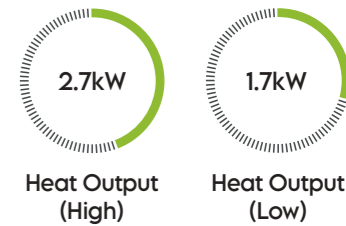
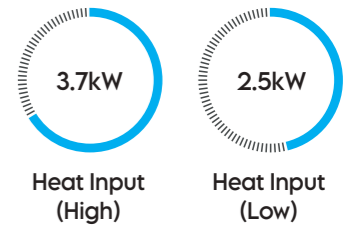

84% EFFICIENCY

DIMENSIONS

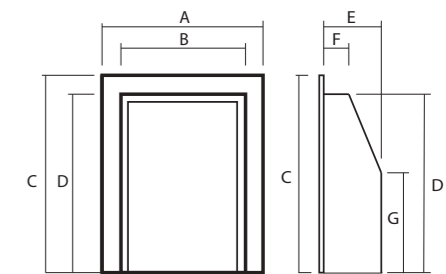

- A) 512mm
- B) 352mm
- C) 607mm
- D) 553mm
- E) 128mm
- F) 111mm
- G) 350mm

The Pesaro HE is a high efficiency glass fronted appliance suitable for Precast, Class 1 and Class 2 flues.

When the most important factor is heat, then the Pesaro mid-depth high efficiency gas fire will deliver. The fire can be fitted with an additional spacer to reduce the effective depth of the appliance.

The Pesaro HE is available in slide control as standard.

Cavello XE



XE

Cavello XE shown with Brass/Black Contemporary Creative trim. Featuring the Be Modern Isabelle Micro Marble surround in manilla.

FLUE OPTIONS



CONTROLS



FUEL BED



FUEL



STANDARD TRIM OPTIONS

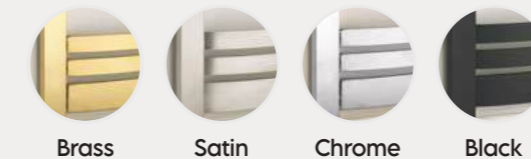

Contemporary trim includes front bars. Trims can be purchased without front bars. For more details see page 74.

PROFILE TRIM OPTIONS

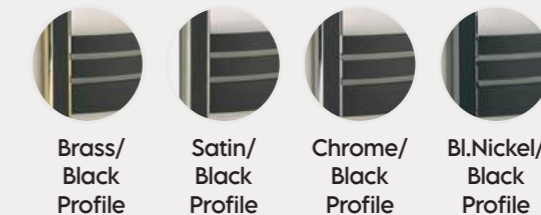

CREATIVE TRIM OPTIONS

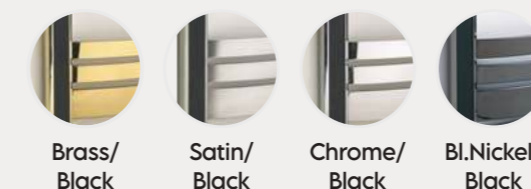

SLIDE LEVER OPTIONS

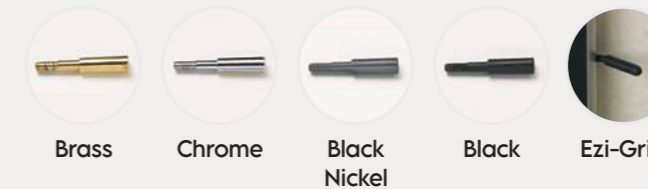

ENERGY EFFICIENCY CLASS F

GAS CONSUMPTION

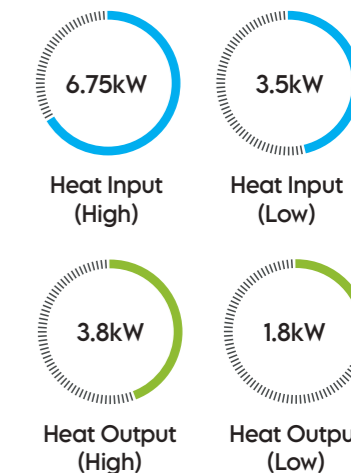

DIMENSIONS

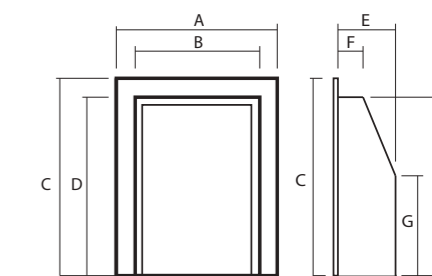

- A) 512mm
- B) 402mm
- C) 607mm
- D) 553mm
- E) 198mm
- F) 130mm
- G) 355mm

The Cavello XE is a realistic open fronted gas fire with a powerful convecting heat exchanger to boost performance.

The Cavello is supplied with the XE System as standard, see page 9 for more details. This convector appliance will produce enough heat to satisfy most of the largest living rooms. It is available in manual and slide control with options of coal and pebble fuel bed effects.

The Wildfire Cavello XE can be supplied with a range of trims to suit the style that you are trying to achieve. See full trim options on page 74.

Montese

(Cadiz Suite)



The Montese shown with Cadiz suite in white/Grey. Also shown in all white (inset). Cadiz suite available with or without lights.



FLUE OPTIONS



CONTROLS



FUEL BED



FUEL



STANDARD TRIM OPTIONS

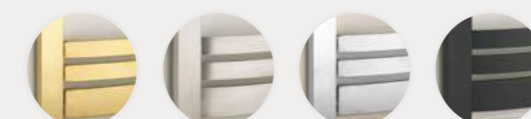

Brass Satin Chrome Black

Contemporary trim includes front bars. Trims can be purchased without front bars. For more details see page 74.

PROFILE TRIM OPTIONS

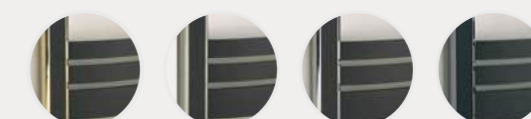

Brass/Black Profile Satin/Black Profile Chrome/Black Profile Bl.Nickel/Black Profile

CREATIVE TRIM OPTIONS

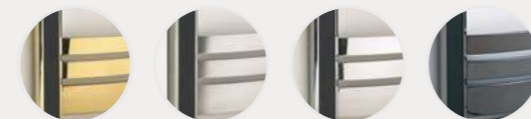

Brass/Black Satin/Black Chrome/Black Bl.Nickel/Black

SLIDE LEVER OPTIONS



Brass Chrome Black Nickel Black Ezi-Grip

STANDARD MANTEL FINISH OPTIONS



White

Grey

Cadiz suite available with or without grey inner border.

DIMENSIONS

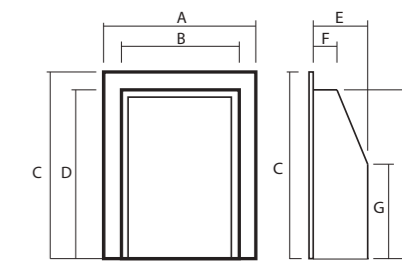

A) 512mm E) 173mm
B) 403mm F) 104mm
C) 607mm G) 328mm
D) 553mm

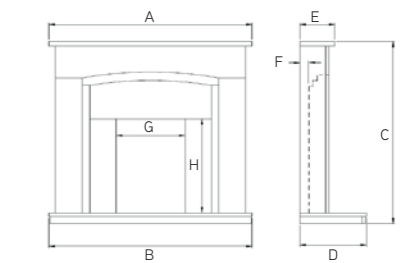

A) 1220mm E) 210mm
B) 1220mm F) 45/75mm
C) 1095mm G) 413mm
D) 400mm H) 565mm

GAS CONSUMPTION

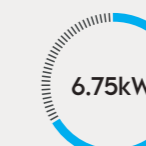

Heat Input (High)

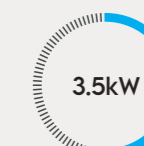

Heat Input (Low)

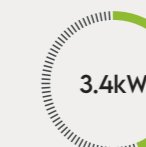

Heat Output (High)



Heat Output (Low)

ENERGY EFFICIENCY CLASS F

The Montese is a stunning fire that will enhance any living room.

The Montese is an authentic looking coal effect gas fire, where realism is the most important factor.

By utilising the broad range of trims that Wildfire provides, you can choose the mood of your room from contemporary to traditional. It is available with pebble and coal fuel bed options and offers an impressive radiant heat output.

The Wildfire Montese is available in manual and slide control. See page 74 for full trim specifications.

XE

Available as XE model with canopy see page 9 for further information.

Ceralis | (Salerno Suite)



(Salerno Suite)



The Ceralis shown with profile contemporary brass/black trim. The Salerno 42" mantel in all white. Also available as 48". Also available in white/grey.



FLUE OPTIONS



CONTROLS



FUEL BED



FUEL



STANDARD TRIM OPTIONS

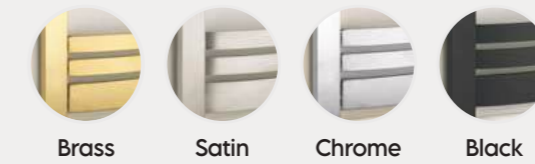

Brass Satin Chrome Black

Front bars are optional. For more details see page 74.

PROFILE TRIM OPTIONS



Brass/Black Profile Satin/Black Profile Chrome/Black Profile Bl.Nickel/Black Profile

CREATIVE TRIM OPTIONS

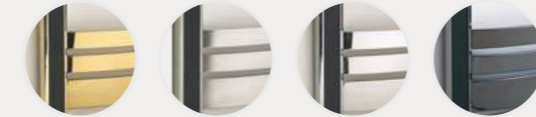

Brass/Black Satin/Black Chrome/Black Bl.Nickel/Black

SLIDE LEVER OPTIONS



Brass Chrome Black Nickel Black Ezi-Grip

STANDARD MANTEL FINISH OPTIONS



White Grey

Available with grey inner border. See similar detail on the Cadiz suite - page 48. Grey border option not available on 42"

DIMENSIONS

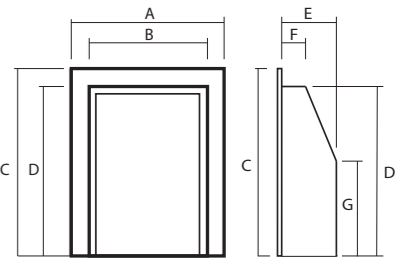

A) 512mm E) 123mm
B) 352mm F) 65mm
C) 607mm G) 300mm
D) 553mm

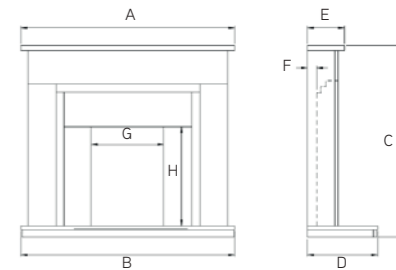

A) 1070mm (42") D) 400mm
1220mm (48") E) 210mm
B) 1070mm (42") F) 45/75mm
1220mm (48") G) 413mm
C) 1050mm (42") H) 565mm
1095mm (48")

GAS CONSUMPTION

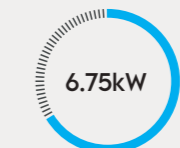

Heat Input (High)



Heat Input (Low)



Heat Output (High)



Heat Output (Low)

ENERGY EFFICIENCY CLASS F

The Ceralis is a powerful slimline appliance that will fit into all flue types. A spacer is available to enable it to be fitted into shallow precast flues.

The realistic fuel bed boasts a powerful flame picture for its size making the Wildfire Ceralis the obvious option when the flue available limits your choice of fire.

The Ceralis is available in manual and slide control with coal and pebble fuel bed options. The slimline fire is a stunning appliance which makes it the first choice for your precast flue. For full trim options see page 74.

XE

Available as XE model with canopy see page 9 for further information.

Trim Options

Choose the trim and fret options from the selection on this page. The Standard and Creative trim and fret options will fit **MOST** of the products in this brochure. The Ellipsis trim will fit manual control fires only. For further fret options consult your retailer.

SLIDE LEVER OPTIONS

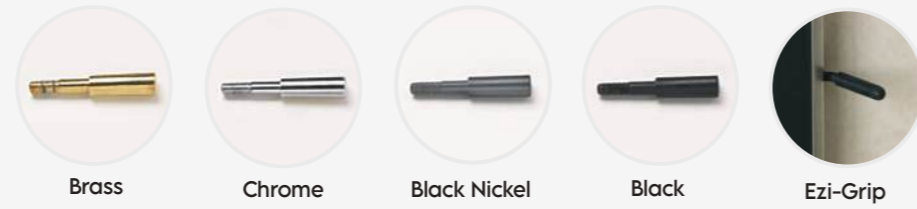

Brass

Chrome

Black Nickel

Black

Ezi-Grip

STANDARD TRIM OPTIONS



Brass

Satin

Chrome

Black

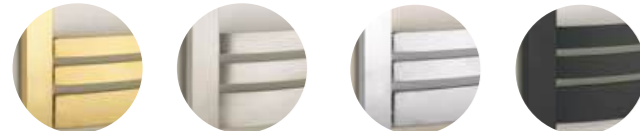

Contemporary Brass

Contemporary Satin

Contemporary Chrome

Contemporary Black

CREATIVE TRIM OPTIONS



Brass/Black

Satin/Black

Chrome/Black

Bl. Nickel/Black

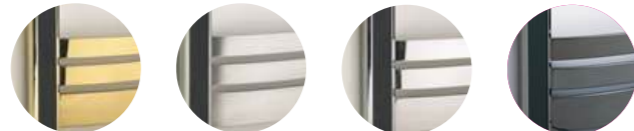

Contemporary Brass/Black

Contemporary Satin/Black

Contemporary Chrome/Black

Contemporary Bl. Nickel/Black

PROFILE TRIM OPTIONS

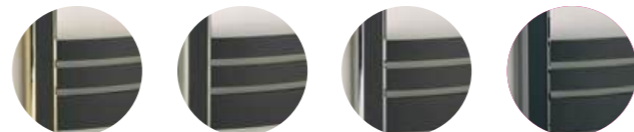

Brass/Black Profile

Satin/Black Profile

Chrome/Black Profile

Bl. Nickel/Black Profile

ELLIPSIS TRIM OPTIONS



Satin/Black

Chrome/Black

4 Sided Satin/Black

4 Sided Chrome/Black

Ellipsis trim only suitable for manual control appliances

RAVEL 550 TRIM OPTIONS



Brass/Black

Satin/Black

Chrome/Black

Bl. Nickel/Black

Anthracite

RAVEL 400 TRIM OPTIONS



Bl. Nickel/Chrome

Anthracite

Note: Both available as 4 sided HIW & Inset Stove Fascia Option (see page 40)

16" SPACER OPTION



AN ADDITIONAL 25MM SPACER IS AVAILABLE TO SUIT ALL 16" X 22" FIRES.

Technical Information

Use the chart below to quickly check the options available for each product contained in this brochure. You will also find the flue types which products can be installed into. For further information consult the manufacturer's installation instructions or ask your local retailer for further advice.

PAGE NO.	FIRES	COAL OPTION	PEBBLE OPTION	LOG OPTION	MANUAL CONTROL	SLIDE CONTROL	PRE-CAST FLUE	CLASS II FLUE	CLASS I FLUE	BALANCED FLUE	XE INCLUDED	XE OPTIONAL	HE	LPG OPTION
10-11	RAVEL MW 1500			✓		✓				✓			✓	
12-13	RAVEL MW 1720			✓		✓				✓			✓	
14-17	RAVEL 750			✓		✓		✓	✓				✓	
18-23	RAVEL 800			✓		✓		✓	✓				✓	
24-25	RAVEL 800 BF			✓		✓				✓			✓	
26-31	RAVEL 600			✓		✓		✓	✓				✓	✓
32-33	RAVEL 600 BF			✓		✓				✓			✓	
34-37	RAVEL 550			✓		✓		✓	✓				✓	
38-43	RAVEL 400			✓		✓		✓	✓				✓	✓
44-45	RAVEL 400 BF			✓		✓				✓			✓	
46-49	RAVEL 400C & 400T STOVE			✓		✓	✓	✓	✓				✓	✓
50-51	RAVEL 400C/T BF STOVE			✓		✓				✓			✓	
52-53	BF960SL			✓		✓				✓			✓	
54-55	THERMES BF	✓			✓	✓				✓			✓	
56-57	ELLIPSIS HIW	✓	✓*		✓			✓	✓	✓		✓	✓**	
58-61	HE950L (STD & PCF)			✓		✓	✓	✓	✓				✓	
62-63	HE900 (STD & PCF)			✓		✓	✓	✓	✓				✓	
64-65	CRESSIDA HE	✓			✓	✓		✓	✓				✓	
66-67	PESARO HE	✓				✓	✓	✓	✓				✓	
68-69	CAVELLO XE	✓	✓		✓	✓		✓	✓		✓		✓	
70-71	MONTESE	✓	✓		✓	✓	✓	✓	✓			✓	✓	
72-73	CERALIS	✓	✓		✓	✓	✓	✓	✓			✓	✓	

*Open fronted only **Glass fronted only

Some things you need to know

All of our electric appliances provide up to 2kW of instantaneous heat. At the push of a button, or from a programmed timer, this clean convected heat will power warmth into your room whenever you need it.

A mesmerising flame effect completes these beautiful products. With stunning log arrangements and a choice of three levels of flame control and up to five brightness/intensity levels. The vibrant flame effects provide that feeling of comfort even when the heat is not switched on. The flame effect system is a safe convenient and efficient design which uses only LED technology to ensure that running costs in flame only mode are extremely low.

The Wildfire range of suites couple this electric fire technology with exquisite micro marble fireplaces. Available in a range of colours (see page 86) these suites all allow a flat to wall installation*

Electric Fireplace Suites



*The Panama E22 and Ravel E16 installed in the Salvador suite require a spacer frame (supplied separately) to allow flat to wall installation. If no spacer is required for this suite then a 65mm recess for the width and height of the appliance is required.



We guarantee* our electric fire products for a period of 1 year from installation and our customer service staff are always on hand to help you with any query you may have with your product.

Our 1 year guarantee* is managed directly by Wildfire through our extensive network of service centres throughout the UK. Choose Wildfire for style, performance, reliability, value and peace of mind.

The distinguishing feature of a flame effect electric fire is the ability to provide a 'feel warm' comfort level with its' mesmerising glow at any time of the year. An energy efficient way to produce a stunning effect with minimal running costs. The instantaneous heat can be called upon on those colder evenings when its just not practical or cost efficient to turn on the central heating.

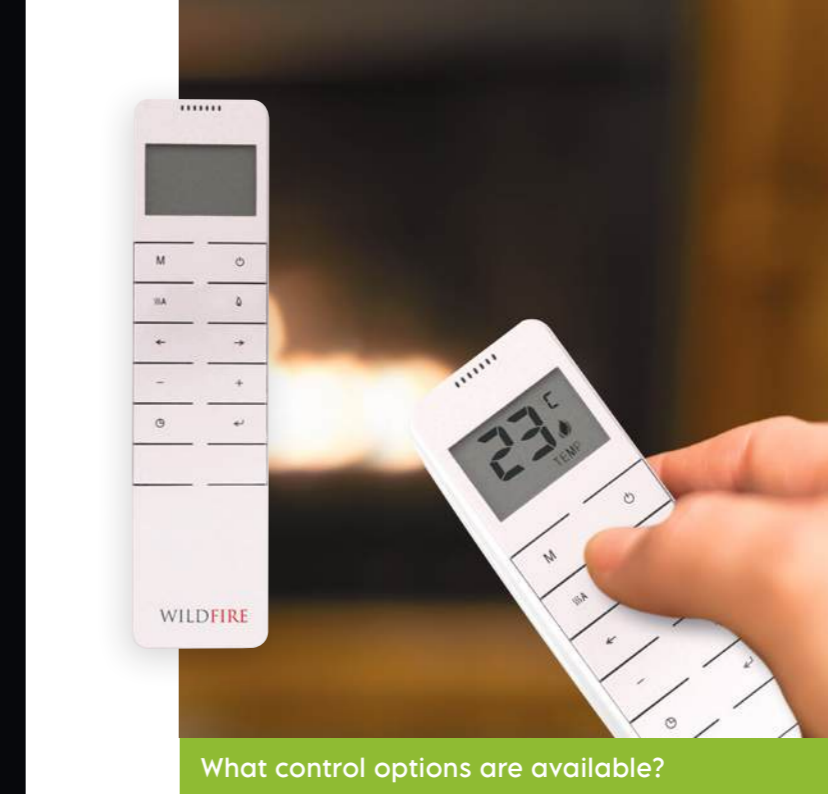

What control options are available?

The multifunction remote control handset provides ultimate controllability for your electric appliance. From 'Normal' operating mode where the appliance will run continually until the required temperature is set, to daily or weekly timer settings to give you complete control over the heating function.

A countdown timer is also included so the unit can be automatically be powered down after a predetermined length of time.

This beautifully styled remote features an internal thermostat to ensure it senses the right temperature in the room. An LCD display features all of the control functions available including flame setting and flame intensity.

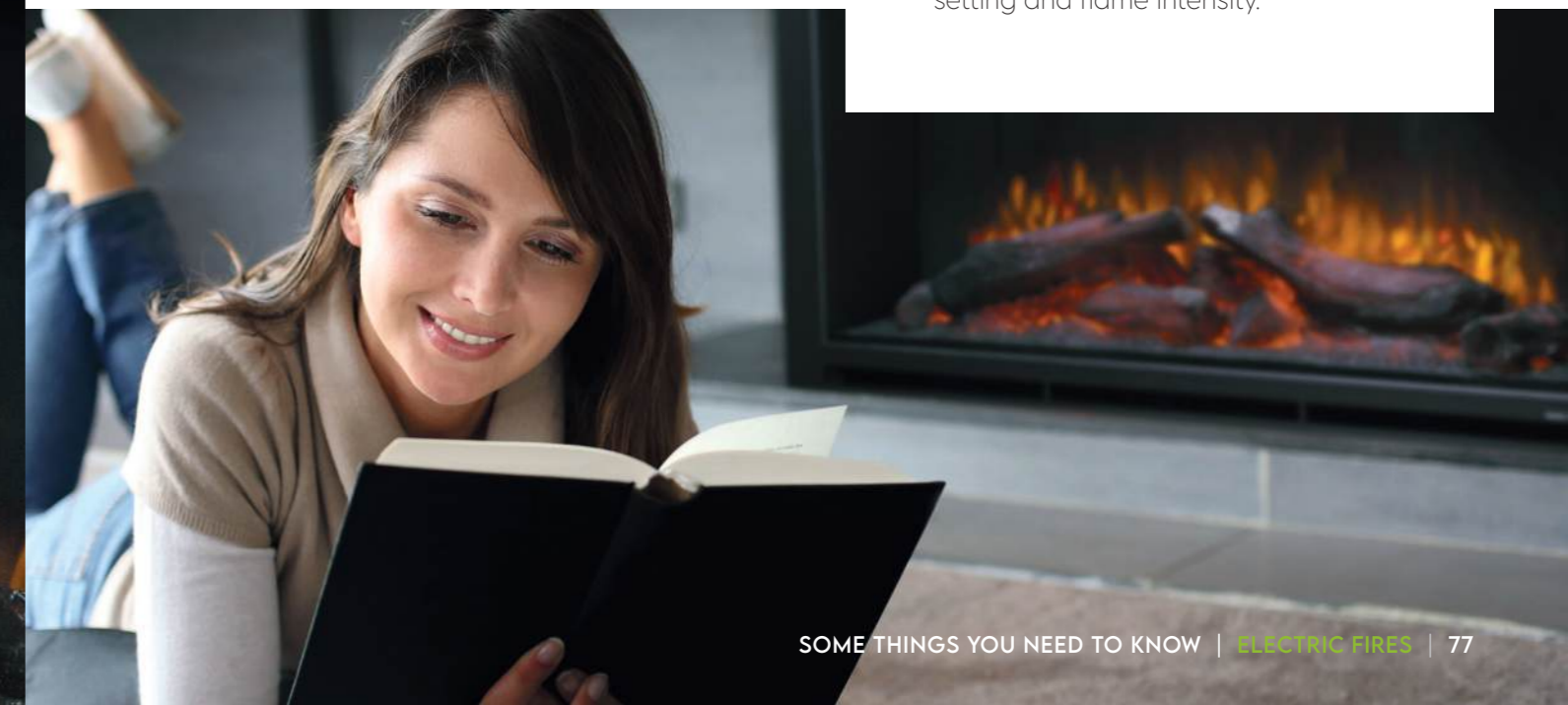

HE 900E | (Avellino Suite)



CONTROL



Remote

FUEL BED



Log

FUEL



Electric

STANDARD MANTEL FINISH OPTIONS

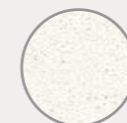

White



Grey

Available with grey inner border - see similar detail on the Seville Suite - page 60.

DIMENSIONS

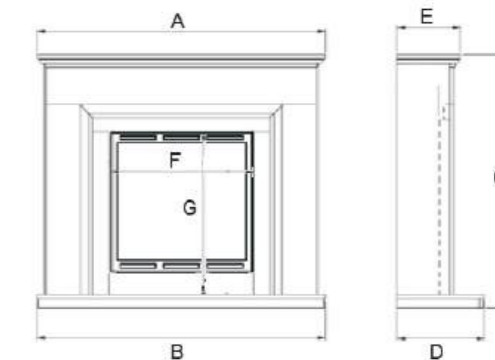

- A) 1320mm
- B) 1320mm
- C) 1159mm
- D) 400mm
- E) 235mm
- F) 660mm
- G) 740mm

For full technical and dimensional specifications refer to pages 86 and 87.

The HE900E Avellino is a 52" flat to wall marble electric fireplace suite.

This fully electronic remote control fireplace offers 7 day thermostatic operation. The suite is available in all white or white with a distinctive grey highlight. A variety of flame effects provide a great solution to suit the mood for the day.

HE 950LE

(Seville Suite)



CONTROL



Remote

FUEL BED



Log

FUEL



Electric

STANDARD MANTEL FINISH OPTIONS



White



Grey

Available with grey inner border - see similar detail on the Seville Suite - page 60.

DIMENSIONS

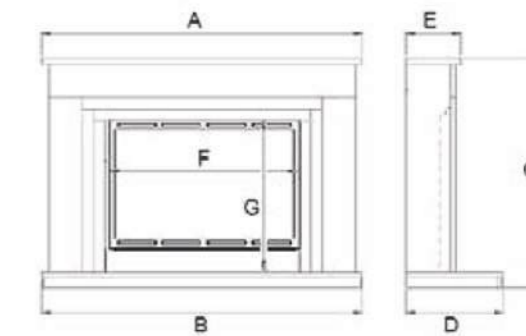

- A) 1320mm
- B) 1320mm
- C) 967mm
- D) 400mm
- E) 235mm
- F) 800mm
- G) 621mm

For full technical and dimensional specifications refer to pages 86 and 87.

The HE950LE Seville is a 52" flat to wall marble electric fireplace suite.

This incredible fireplace has been launched to complement the already successful, multi award winning HE950L Seville gas suite. It is available in the same flawless micro marble colour options, white or white with grey slip highlights. The appliance is fully thermostatic and has timers to allow heating to take place at the appropriate times.

Panama E22

(Salvador Suite)



- CONTROL**
Remote
- FUEL BED**
Log
- FUEL**
Electric

STANDARD MANTEL FINISH OPTIONS

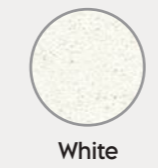

PANAMA TRIM OPTIONS

- Brass/Black
- Satin/Black
- Chrome/Black
- Bl.Nickel/Black
- Anthracite

DIMENSIONS

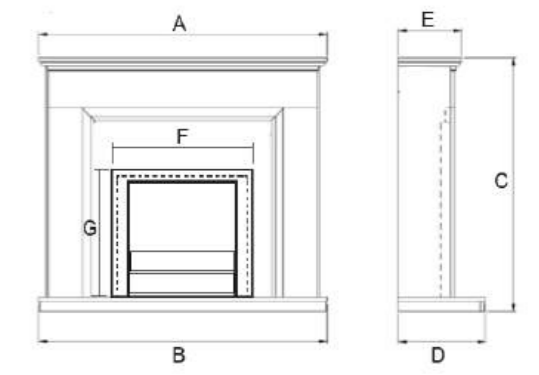

- A) 1370mm
- B) 1370mm
- C) 1160mm
- D) 400mm
- E) 230mm
- F) 614mm
- G) 611mm

For full technical and dimensional specifications refer to pages 86 and 87.

The Panama E22 Salvador is a 54" micro marble electric fireplace suite, available in all white.

The Panama E22 can be supplied with numerous trim options, from the black anthracite or the two tone anodised range featuring brass, satin, chrome, black nickel & the new black nickel/chrome effect. The appliance is a fully electronic remote control fireplace offering a 7 day thermostatic operation. A variety of flame effects can be selected using the digital remote control, along with a whole range of other programmable features. For full information on the remote system refer to page 86.

This product can be installed onto a flat wall if a 65mm spacer (available separately) is fitted. Alternatively a recess behind the fireplace can be made to accept the appliance rear section, talk to your retailer for further details.

RAVEL E16

(Salvador Suite)



Ravel shown with Contemporary Bl.Nickel/Chrome trim.

Featured with a Wildfire Salvador 54" surround in Manilla Micro Marble

CONTROL



Remote

FUEL BED



Log

FUEL



Electric

STANDARD MANTEL FINISH OPTIONS

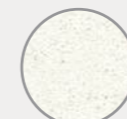

White

RAVEL TRIM OPTIONS

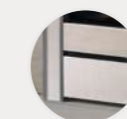

Bl.Nickel/
Chrome

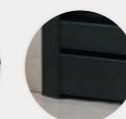

Anthracite

DIMENSIONS

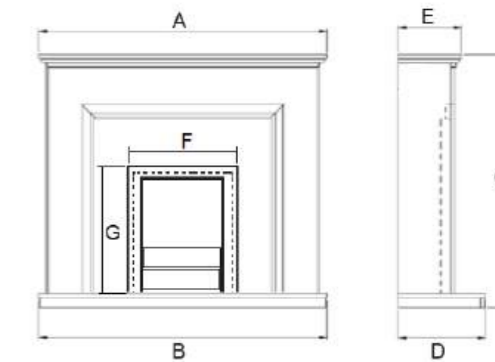

A) 1370mm
B) 1370mm
C) 1160mm

D) 400mm
E) 230mm
F) 512mm

G) 611mm

For full technical and dimensional specifications refer to pages 86 and 87.

The Ravel E16 Salvador is a 54" micro marble electric fireplace suite, available in all white.

The Ravel E16 can be supplied with either a black anthracite or a black nickel and chrome trim option. The fireplace can be installed onto a flat wall if a spacer (available separately) is fitted. Alternatively a recess behind the fireplace can be made to accept the appliance rear section, talk to your retailer for further details. The appliance is a fully electronic remote control fireplace offering a 7 day thermostatic operation. A variety of flame effects can be selected using the digital remote control, along with a whole range of other programmable features.

Marble and Trim options electrical

	AVELLINO HE900E	SEVILLE HE950LE	AVELLINO PANAMA E22	SALVADOR PANAMA E22	SALVADOR E16
MARBLE COLOURS	W / WG	W / WG	W / WG	W	W
TRIM OPTION	As pictured	As pictured	Br / Sa / Ch / An / BN	Br / Sa / Ch / An / BN	Br / Sa / Ch / An / BN
REMOTE CONTROL	Yes	Yes	Yes	Yes	Yes
THERMOSTATIC	Yes	Yes	Yes	Yes	Yes
PROGRAMMABLE TIMER	Yes	Yes	Yes	Yes	Yes
FLAME COLOUR SETTINGS	3	3	3	3	3
FLAME INTENSITY SETTINGS	5	5	5	5	5
MAX HEATER OUTPUT	2kW	2kW	2kW	2kW	2kW
SPACER OPTION FOR FLAT-WALL FIX	N/A	N/A	N/A	Yes	Yes

KEY Marble Colours: W: White WG: White with Grey Slips
 Trim Options: Br: Brass/Black Sa: Satin/Black Ch: Chrome Black An: Anthracite BN: Black Nickel/Black

MARBLE COLOURS

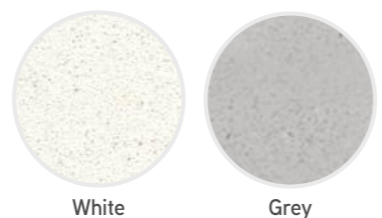

White Grey

TRIM OPTIONS



Brass/Black Satin/Black Chrome/Black



Bl. Nickel/Black Anthracite

PAGE NO.	ELECTRIC FIREPLACE SUITE	HEARTH WIDTH	HEARTH DEPTH	SHELF WIDTH	SHELF DEPTH	OVERALL HEIGHT
78-79	AVELLINO HE900E	1320mm	400mm	1320mm	290mm	1159mm
80-81	SEVILLE HE950LE	1320mm	400mm	1320mm	290mm	967mm
82-83	SALVADOR PANAMA E22	1370mm	400mm	1370mm	230mm	1160mm
84-85	SALVADOR RAVEL E16	1370mm	400mm	1370mm	230mm	1160mm





Sales Enquiries

sales@hearthproducts.co.uk

Technical Enquiries

customerservice@hearthproducts.co.uk

Telephone

01785 225401

Fax

01785 225501

HEARTH PRODUCTS

Hearth Products Ltd, Unit 14 Brindley Close,
Tollgate Industrial Estate, Stafford ST16 3SU



www.wildfiregas.co.uk
www.wildfireelectric.co.uk

Scan the QR code with your mobile device to
be directed to the Wildfire website.



All details in this brochure are for illustrative purposes only. We reserve the right to change details due to constant product improvement. Always check specifications with your retailer prior to purchase.

